

Carbohydrate heterogeneity of fibronectins. Synovial fluid fibronectin resembles the form secreted by cultured synoviocytes but differs from the plasma form.

S Carsons, ... , H S Diamond, E Berkowitz

J Clin Invest. 1987;**80**(5):1342-1349. <https://doi.org/10.1172/JCI113211>.

Research Article

Large quantities of fibronectin (Fn) are present in inflammatory synovial fluid. Inflammatory synovial fluid Fn, while indistinguishable from plasma Fn on the basis of reactivity to polyclonal antibodies, displays alterations in molecular size and charge. Since biochemical differences between plasma and synovial fluid fibronectins might be in part due to differences in glycosylation we have compared the carbohydrate composition of plasma Fn, synovial fluid Fn, and Fn from synoviocyte conditioned medium by biochemical assay, glycopeptide analysis, and binding to a series of lectins. Synovial fluid Fn has a greater carbohydrate content but contains less sialic acid when compared with plasma Fn. Glycopeptides formed from synovial fluid Fn are smaller than plasma Fn glycopeptides. These data suggest the presence of an additional N-linked oligosaccharide chain on synovial fluid Fn. In addition, synovial fluid Fn contains N-acetyl galactosamine indicating the presence of O-linked oligosaccharides. Synovial fluid Fn and Fn isolated from rheumatoid synoviocyte-conditioned medium display strong reactivity with the lectins wheat germ agglutinin (WGA) and peanut agglutinin (PNA), whereas normal and rheumatoid plasma Fn react weakly. The PNA reactivity of synovial fluid Fn is mediated by terminal beta-galactose residues on the gelatin-binding domain, whereas the enhanced WGA reactivity of synovial Fn is mediated by a sialic acid containing oligosaccharide located on a 27-kD C-terminal fragment. These data demonstrate domain-specific biochemical differences between [...]

Find the latest version:

<https://jci.me/113211/pdf>



Carbohydrate Heterogeneity of Fibronectins

Synovial Fluid Fibronectin Resembles the Form Secreted by Cultured Synoviocytes but Differs from the Plasma Form

Steven Carsons,* Beverly B. Lavietes,* Amalia Slomiany,† Herbert S. Diamond,* and Ellen Berkowitz*

*Division of Clinical Immunology, Department of Medicine, Long Island Jewish Medical Center, New Hyde Park, New York 11042; State University of New York at Stony Brook, Stony Brook, New York 11794; †Gastroenterology Research Laboratory, Department of Medicine, New York Medical College, Valhalla, New York 10595

Abstract

Large quantities of fibronectin (Fn) are present in inflammatory synovial fluid. Inflammatory synovial fluid Fn, while indistinguishable from plasma Fn on the basis of reactivity to polyclonal antibodies, displays alterations in molecular size and charge. Since biochemical differences between plasma and synovial fluid fibronectins might be in part due to differences in glycosylation we have compared the carbohydrate composition of plasma Fn, synovial fluid Fn, and Fn from synoviocyte conditioned medium by biochemical assay, glycopeptide analysis, and binding to a series of lectins.

Synovial fluid Fn has a greater carbohydrate content but contains less sialic acid when compared with plasma Fn. Glycopeptides formed from synovial fluid Fn are smaller than plasma Fn glycopeptides. These data suggest the presence of an additional N-linked oligosaccharide chain on synovial fluid Fn. In addition, synovial fluid Fn contains N-acetyl galactosamine indicating the presence of O-linked oligosaccharides. Synovial fluid Fn and Fn isolated from rheumatoid synoviocyte-conditioned medium display strong reactivity with the lectins wheat germ agglutinin (WGA) and peanut agglutinin (PNA), whereas normal and rheumatoid plasma Fn react weakly. The PNA reactivity of synovial fluid Fn is mediated by terminal β -galactose residues on the gelatin-binding domain, whereas the enhanced WGA reactivity of synovial Fn is mediated by a sialic acid containing oligosaccharide located on a 27-kD C-terminal fragment. These data demonstrate domain-specific biochemical differences between plasma and synovial fluid fibronectins. These differences suggest a local origin for synovial fluid Fn and may contribute to functional differences between these forms of the protein.

Introduction

Elevated concentrations of Fn¹ present in inflammatory synovial fluid (1–5) may originate by diffusion from plasma

(plasma form) or by increased local turnover in joint tissue (cellular form). While in vitro synthesis of Fn by synoviocytes has been demonstrated (6, 7), the form of Fn present in synovial fluid is not known. Although indistinguishable on the basis of reactivity to polyclonal antibodies, plasma Fn and inflammatory synovial fluid Fn have been shown to differ in molecular size and charge (4, 5, 8) and to display functional variations (8).

Different forms of Fn display functional alterations that have been shown to be in part due to heterogeneity of glycosylation (9–13). Glycosylation has been shown to affect Fn resistance to proteolysis and collagen-binding affinity. Characteristic glycosylation profiles have been identified for the plasma, cell matrix, and embryonal forms of Fn. Since these biochemical differences are useful in identifying forms of Fn present in Fn mixtures and in identifying domain-associated functional heterogeneity among fibronectins, we investigated the carbohydrate composition of Fn isolated from normal plasma, rheumatoid plasma, inflammatory synovial fluid and rheumatoid synoviocyte-conditioned medium. These studies were performed to identify specific regions of biochemical diversity between plasma and synovial fluid Fn. The results identify domain-associated regions of carbohydrate heterogeneity among these fibronectins that may be responsible for functional differences between the forms present in the plasma and joints of patients with rheumatic disease.

Methods

Patients. Normal human plasma was obtained from the New York Blood Center. Plasma and synovial fluid from patients with rheumatic disease was collected into 6 mM EDTA, centrifuged at 1,000 g to remove cells and stored frozen at -30°C . Primary explant cultures of rheumatoid synovium removed at joint replacement surgery were maintained in Dulbecco's modified Eagles medium (DME) (Gibco Laboratories, Grand Island, NY) containing 10% pooled human serum depleted of Fn as previously described (6). Conditioned medium was collected and frozen at -30°C for subsequent Fn isolation.

Isolation of fibronectin and limited proteolytic digestion. Fn was isolated by affinity chromatography on Sepharose 4B and gelatin-Sepharose 4B (Pharmacia Fine Chemicals, Piscataway, NJ) as previously described (8). Purified fibronectins were digested by chymotrypsin (Calbiochem-Behring, La Jolla, CA) at 1:50 wt/wt for 1 h at 23°C in 0.05 M Tris, 0.15 M NaCl, 1 mM CaCl_2 , pH 7.0. The reaction was stopped by freezing to -20°C . Fragments containing collagen and heparin binding domains were separated by chromatography of digests

Address reprint requests to Dr. Steven Carsons, Clinical Immunology, Room B210, Long Island Jewish Medical Center, New Hyde Park, NY 11042.

Presented in part at the 49th Annual Meeting of the American Rheumatism Association and published in abstract form (1985. *Arthritis Rheum.* 28:S35; 1985. *Clin. Res.* 33:504A).

Received for publication 5 June 1987 and in revised form 18 May 1987.

J. Clin. Invest.

© The American Society for Clinical Investigation, Inc.

0021-9738/87/11/1342/08 \$2.00

Volume 80, November 1987, 1342–1349

1. **Abbreviations used in this paper:** Con A, concanavalin A; DME, Dulbecco's modified Eagles medium; Fn, fibronectin; PNA, peanut agglutinin; SDS-PAGE, sodium dodecyl sulfate polyacrylamide gel electrophoresis; WGA, wheat germ agglutinin.

on gelatin-Sepharose 4B or heparin-Sepharose 6BCL (Pharmacia Fine Chemicals). Bound fragments were eluted with 8 M urea or 0.5 M NaCl, respectively.

Fibronectin 140-kD fragments were further digested with *Staphylococcus aureus* V8 protease (Miles Laboratories, Elkhart, IN) in 0.1 M Tris HCl, pH 7.2 for 30 min at 23°C. The reaction was stopped by freezing to -20°C.

Biochemical determinations. Identification of the individual monosaccharides of plasma and synovial fluid fibronectins was accomplished by gas chromatography (GC-65, Beckman Instruments, Inc., Fullerton, CA) of pooled, purified fibronectins after methanolysis, re-N-acetylation and derivitization with silylating reagents (14).

Quantitation of the sialic acid content of individual plasma, synovial fluid and synoviocyte culture medium fibronectins was performed by the periodate thiobarbituric acid method (15) using sialic acid purified from human urine (Sigma Chemical Co., St. Louis, MO) as a standard. Hexose content was similarly assayed using the phenol sulfuric acid method and galactose as a standard (16).

Glycopeptide analysis. Purified Fn from plasma and synovial fluid were dialyzed against 0.1 M Tris, 0.5 M NaCl, 10 mM CaCl₂, pH 7. Concentrations were adjusted to ~ 1 mg/ml before adding pronase (1:100 wt/wt under toluene). Samples were incubated at 37°C with shaking; fresh pronase was added after 24 and 48 h of incubation. After lyophilization, the digest was resuspended in 1 ml of 0.1 M ammonium bicarbonate, pH 8, and chromatographed on a 1.5 × 81-cm column of Sephadex G50. Fractions (5 ml) were collected, lyophilized, resuspended in distilled, deionized water, and assayed for hexose as above.

To examine Fn glycopeptides synthesized by rheumatoid synoviocytes in culture, a 75-cm flask was labeled with 200 μCi [³H]mannose (40.6 Ci/mM) (New England Nuclear, Boston, MA) for 24 h. Labeled Fn was immunoprecipitated from the conditioned medium using rabbit antihuman Fn followed by goat anti-rabbit IgG. After washing with cold phosphate-buffered saline (PBS), the immunoprecipitate was redissolved in 0.5 ml of Tris-NaCl buffer and digested with pronase as above. Labeled Fn glycopeptides were chromatographed on Sephadex G 50. 50 μl of each column fraction was dissolved in Aquasol (New England Nuclear) and radioactivity determined in a liquid scintillation counter (Beckman LS-9000).

Electrophoresis and protein blotting. Sodium dodecyl sulfate-polyacrylamide gel electrophoresis (SDS-PAGE) was performed by Laemmli's method (17) using a 3% stacking gel. Intact Fn molecules were resolved with a 7% gel and proteolytic digests with a 10% gel. Proteins were then transferred to nitrocellulose by Towbin's method (18) using equipment and reagents from Bio-Rad Laboratories, Richmond, CA. Nitrocellulose papers containing transferred Fns were blocked with 3% bovine serum albumin (BSA) rather than gelatin. Each electrophoresis and transfer was performed with replicate groups of proteins. The nitrocellulose was then cut and a series of proteins was stained with anti-Fn antibodies to identify immunoreactive fragments and monitor protein loading. Replicate series were stained with peroxidase labeled lectins (Sigma Chemical Co.) to detect specific carbohydrate sequences (19).

Lectin binding of purified Fn was also assessed by dot blotting. A 2-μl sample of a solution of purified plasma or synovial fluid Fn (1 mg/ml) was spotted onto replicate nitrocellulose papers. After air drying, the papers were blocked with BSA and stained with peroxidase labeled lectins as above.

To assure the carbohydrate specificity of lectin binding to Fn, labeled lectins were preincubated with 200-mM concentrations of ligand sugars in PBS for 45 min at 23°C before blotting. Concanavalin A (Con A) reactivity was inhibited by α-methyl mannoside (Sigma Chemical Co.); wheat germ agglutination (WGA) reactivity was entirely inhibited by a 1:1 mixture of N-acetyl neuraminic acid and N-acetyl glucosamine (Sigma Chemical Co.); peanut agglutination (PNA) reactivity was inhibited by galactose (Fisher Scientific Co., Pittsburgh, PA).

For some experiments fibronectins were treated with neuraminidase (Sigma Chemical Co.), 1:10 wt/wt in 0.1 M sodium acetate, pH

6.0, for 16 h at 37°C before electrophoresis and lectin binding analysis. Similarly, some samples were pretreated with hyaluronidase (Sigma Chemical Co.) for 1 h in 0.05 M Tris-HCl, pH 7.0.

Statistical analysis. All data are expressed as the mean ± SE. Significance was determined using Student's *t* test for unpaired samples.

Results

Biochemical analysis of carbohydrate content. Gas chromatographic analysis of pooled, purified fibronectins from normal plasma and synovial fluid (Fig. 1) revealed that both forms contained mannose, galactose, and N-acetylglucosamine consistent with the presence N-linked oligosaccharide side chains. Neither form of the protein contained fucose. Whereas the plasma Fn samples demonstrated only trace amounts of N-acetylgalactosamine, the synovial fluid form contained a significant amount, ~ 0.5% residue weight as estimated from gas chromatographic (GC) analysis.

Quantitative comparison of hexose content between six individual plasma Fn samples and seven synovial fluid Fn samples (Table I) revealed that synovial fluid Fn contained significantly more hexose (4.2 ± 0.2%) than did plasma Fn (2.8 ± 0.4%) (*P* = 0.007). Plasma Fn, however, had a greater sialic acid content (1.2 ± 0.2%) than did synovial fluid Fn (0.70 ± 0.09%) (*P* = 0.036). The sialic acid content of Fn isolated from the conditioned media of two synoviocyte cultures (0.86 and 0.75%) was similar to that of synovial fluid Fn (Table I).

Analysis of Fn glycopeptides. Glycopeptides prepared from purified plasma Fn, synovial fluid Fn and [³H]mannose-labeled synoviocyte culture Fn were analyzed by gel filtration on Sephadex G-50 (Fig. 2). Fn glycopeptides synthesized by human synoviocytes in culture (panel C) emerged as a single peak coeluting with transferrin glycopeptides (*M_r* = 2800, arrow). Synovial fluid Fn glycopeptides (panel A) were somewhat heterogeneous and had an elution position of lower molecular mass (2,200–2,600 D) when compared with either transferrin, plasma Fn, or synoviocyte Fn glycopeptides.

Heterogeneity of carbohydrate distribution on synovial and plasma fibronectins. The lectin binding patterns of purified normal plasma Fn, and synovial fluid Fn are shown in Fig. 3. Plasma and synovial fluid Fn reacted equally with antifibro-

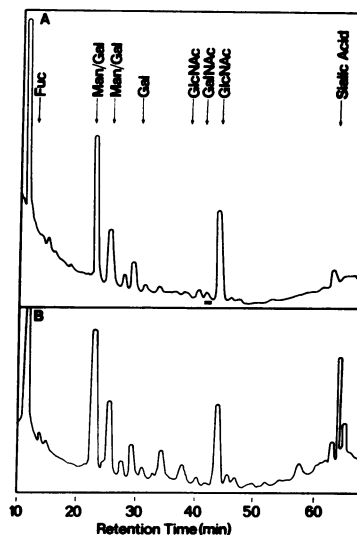

Figure 1. Gas chromatographic profiles of derivitized monosaccharides formed from pooled synovial fluid fibronectins (A) and plasma fibronectins (B). Arrows indicate elution positions of major monosaccharides. Synovial fluid fibronectin contains N-acetylgalactosamine (underlined), which elutes at 41.2 min. Neither preparation contains fucose.

Table I. Quantitative Comparison of Hexose and Sialic Acid Content of Individual Plasma and Synovial Fluid FN Samples

Hexose Sample	Diagnosis*	% Hexose [‡]
PFN 910	Normal	4.1
PFN 104	Normal	3.7
PFN 117	Normal	2.3
PFN 213	Normal	2.5
PFN 220	Normal	1.9
PFN 321	Normal	2.2
mean±SE		2.8±0.4
SF POW	RA	3.8
SF SVO	RA	4.3
SF WAL	RA	4.3
SF MAH	RA	3.4
SF BUR	RA	4.8
SF RAB	PSA	5.4
SF MAL	OA	3.5
mean±SE		4.2±0.2
Sialic acid Sample	Diagnosis	% Sialic acid [§]
PFN 104	Normal	1.0
PFN 614	Normal	1.4
PFN 94	Normal	1.3
PFN 1212	Normal	0.9
mean±SE		1.2±0.23
SF RAS	RA	0.8
SF POW	RA	0.6
SF WAL	RA	0.6
SF MAL	RA	0.7
mean±SE		0.70±0.09
Synoviocyte culture 8410	RA	0.86
Synoviocyte culture 8411	RA	0.75

* RA, rheumatoid arthritis; PSA, psoriatic arthritis; OA, osteoarthritis; [‡] P, 0.007 P vs SF; [§] P, 0.034 P vs SF.

nectin and Con A. Synovial fluid Fn demonstrated strong reactivity to WGA (eight samples examined), whereas normal plasma Fn reacted weakly (four different preparations) (Fig. 3 a).

Synovial fluid Fn and plasma Fn obtained simultaneously from a patient with RA also demonstrated differential reactivity to WGA (Fig. 3 b).

Differences between plasma and synovial fluid Fn were also demonstrated with PNA. Four synovial fluid fibronectins uniformly displayed strong reactivity to PNA, whereas Fn isolated from normal plasma (three different preparations) and rheumatoid plasma failed to react with PNA (Fig. 3 c).

Fibronectin secreted by rheumatoid synoviocytes in culture displayed a lectin binding pattern similar to that of synovial fluid Fn, binding weakly to Con A but strongly to PNA (Fig. 4 a) and WGA (Fig. 4 b).

Effect of neuraminidase treatment on lectin binding patterns. WGA reacts with sialic acid and N-acetylglucosamine residues on glycoproteins (20). PNA reacts with (Galβ₁₋₃GalNAc) residues but reactivity is blocked by terminal sialic acid

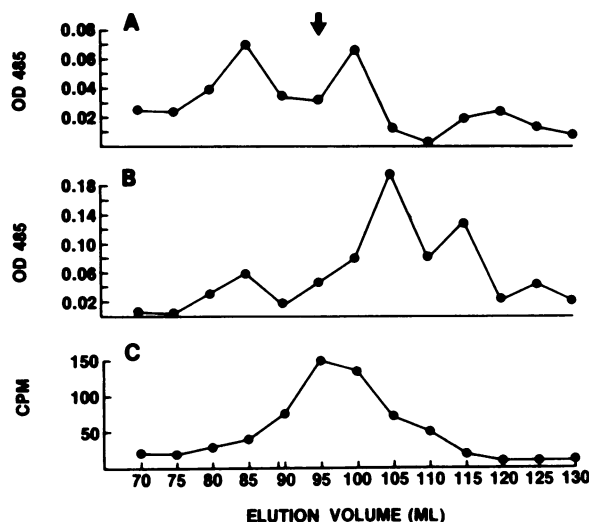

Figure 2. Chromatography of Fn glycopeptides on Sephadex G-50. (A and B) Hexose content of fractions measured colorimetrically at 485 nm. (C) Counts per minute [³H]mannose incorporated in the glycopeptide. (A) Plasma Fn glycopeptides. (B) Synovial fluid Fn glycopeptides. (C) Fn glycopeptides synthesized and secreted by primary explant rheumatoid synoviocytes. (Arrow) Elution position of transferrin glycopeptides, *M_r* = 2,800.

(19). Therefore, neuraminidase digestion was utilized to examine the contribution of sialic acid heterogeneity in producing the observed lectin binding patterns (Fig. 5).

Neuraminidase treatment did not alter the WGA reactivity of plasma Fn (Fig. 5). After neuraminidase treatment, however, plasma Fn reacted strongly with PNA. The PNA staining intensity of synovial fluid Fn was somewhat further enhanced by neuraminidase treatment, whereas neuraminidase decreased the WGA reactivity of synovial fluid Fn slightly. Hyaluronidase treatment did not alter the lectin reactivity of synovial fluid Fn (data not shown).

Lectin binding patterns of fibronectin chymotryptic digests. Chymotrypsin cleaves Fn into large (140–160 kD) C-terminal fragments and 30–60 kD gelatin N-terminal fragments. Fig. 6 a shows the lectin binding patterns of plasma and synovial fluid Fn chymotryptic digests separated on a 10% gel. The gelatin-binding and nonbinding chymotryptic fragments from both plasma and synovial fluid Fn reacted equally with antifibronectin and Con A. Although intact plasma Fn consistently demonstrated weak reactivity to WGA (Fig. 3), the plasma Fn gelatin-binding fragments demonstrated strong reactivity after chymotryptic cleavage, equalling the synovial fluid gelatin-binding fragments (Fig. 6 a, lanes 11 and 12). On the other hand, the plasma Fn 140–160-kD fragments, like intact plasma Fn, displayed minimal WGA reactivity while the synovial fluid 140–160 kD fragments reacted strongly (Fig. 6 a, lanes 9 and 10).

After chymotryptic digestion, weak PNA reactivity was seen only on synovial fluid Fn gelatin binding fragments (data not shown).

The lectin binding patterns of the nongelatin binding C-terminal fragments, were reexamined after electrophoresis on a 7% gel (Fig. 6 b). The major glycosylated fragments seen at 160, 140, and 120 kD all reacted with Con A. The 140-kD synovial fluid Fn fragment clearly showed the most intense

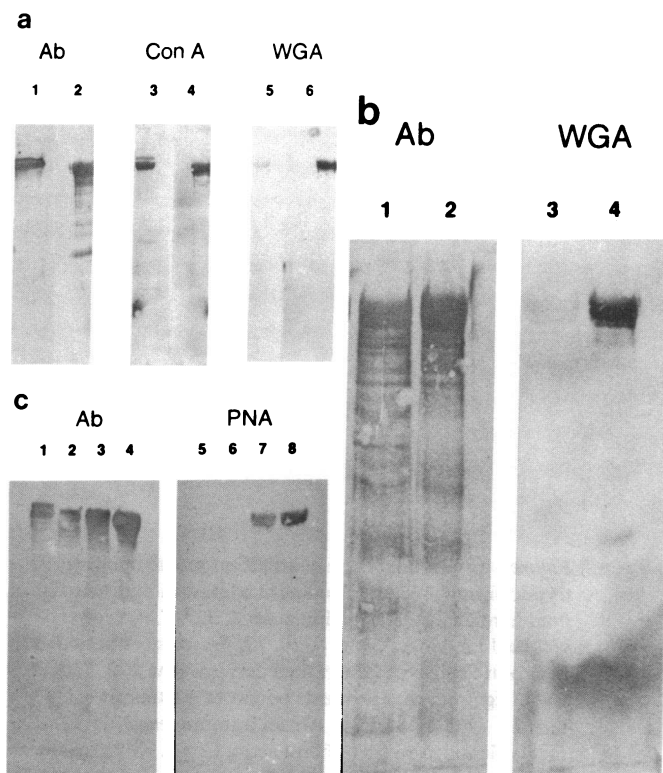

Figure 3. (a) Reactivity of plasma and synovial fluid Fn with Con A and WGA. Western blots of purified normal plasma Fn (lanes 1, 3, 5) and Fn purified from inflammatory synovial fluid (lanes 2, 4, 6) electrophoresed on a 7% slab gel (14 μ g protein per lane). Fibronectins were stained with peroxidase labeled antifibronectin (lanes 1 and 2), Con A (lanes 2 and 5) and WGA (lanes 5 and 6). (b) WGA reactivity of plasma and synovial fluid Fn obtained from the same patient. Western blots of purified plasma Fn (lanes 1 and 3) and purified synovial fluid Fn (lane 2 and 4) obtained simultaneously from a patient with RA (17 μ g protein per lane). Ab, proteins stained with peroxidase-labeled antifibronectin. WGA, proteins stained with peroxidase-labeled WGA. For this study the fibronectins were prepared without protease inhibitors, hence more extensive degradation is observed. (c) PNA reactivity of plasma and synovial fluid fibronectins. Western blot of purified normal plasma Fn, (22 μ g protein) is shown in lanes 1 and 5. Lanes 2 and 6 and 3 and 7 contain 22 μ g of Fn purified from the plasma and synovial fluid, respectively, of a RA patient (see Fig. 1 b). Lanes 4 and 8 contain 23 μ g of Fn purified from a different RA synovial fluid. Ab, proteins stained with peroxidase labeled antifibronectin. PNA, protein stained with peroxidase labeled PNA.

reactivity to WGA (arrow, Fig. 6 b). This fragment did not bind heparin-Sepharose (Fig. 6 c, NB), eluting in the flow-through fraction. The 160-kD fragment bound heparin, requiring 0.5 M NaCl for elution (Fig. 6 c, B). Further digestion of the 140-kD synovial fluid and plasma Fn fragments with *S. aureus* V8 protease showed that selective WGA binding was localized to a 27-kD synovial fluid Fn fragment (Fig. 6 d). Preincubation of WGA with 0.2 M sialic acid inhibited WGA binding to the 140–160-kD synovial fluid fragments.

Discussion

Fibronectins are a family of glycoproteins in which differences in primary structure are generated by differential mRNA

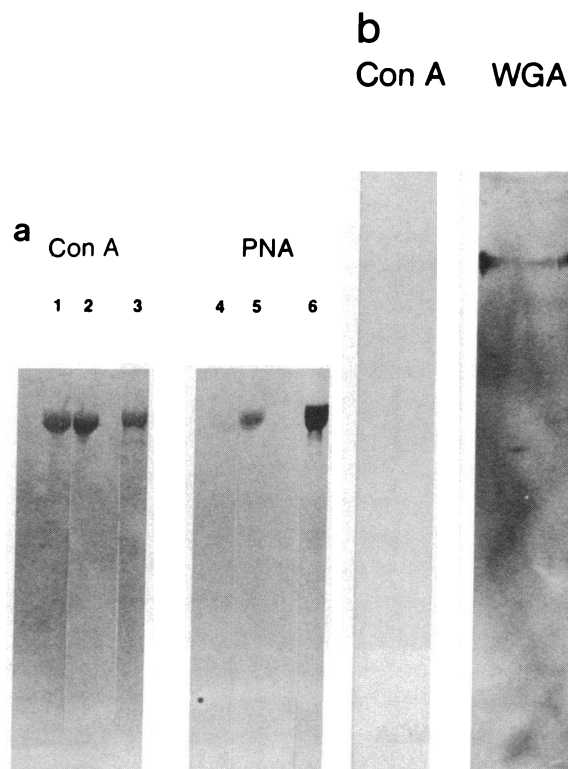

Figure 4. (a) Reactivity of plasma, synovial fluid and synoviocyte culture to PNA and Con A. Western blot of purified normal plasma Fn (22 μ g protein) (lanes 1 and 4), purified rheumatoid synovial fluid Fn (17 μ g protein) (lanes 2 and 5), and Fn purified from the conditioned medium of a primary culture of rheumatoid synovium (11 μ g protein) (lanes 3 and 6). Con A, proteins stained with peroxidase labeled Con A. PNA, proteins stained with peroxidase-labeled PNA. The synovium used for explant culture and the synovial fluid were obtained simultaneously from the same joint. (b) Reactivity of synoviocyte culture Fn to WGA and Con A. Western blot of replicate lanes of Fn (8 μ g) purified from conditioned medium of a primary rheumatoid explant culture. Con A, peroxidase labeled Con A. WGA, peroxidase labeled WGA. Strong reactivity of synoviocyte Fn with WGA is similar to that observed for synovial fluid Fn (Figs. 1 a and b).

splicing (21). In normal and pathological states additional posttranslational modifications have been demonstrated, including heterogeneity in glycosylation (9–13).

Our results indicate that the carbohydrate content and

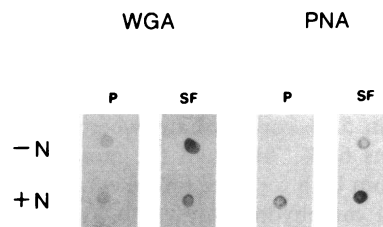

Figure 5. Effect of neuraminidase treatment on WGA and PNA reactivity of fibronectins in a dot blot assay. Each spot contains 2 μ g of purified protein. WGA-P, plasma Fn stained with peroxidase labeled WGA; WGA-SF, rheumatoid synovial fluid Fn stained with peroxidase labeled WGA; PNA-P, plasma Fn stained with peroxidase labeled PNA; PNA-SF, synovial fluid Fn stained with peroxidase labeled PNA; -N, without neuraminidase treatment; +N, treatment with neuraminidase prior to dot blot.

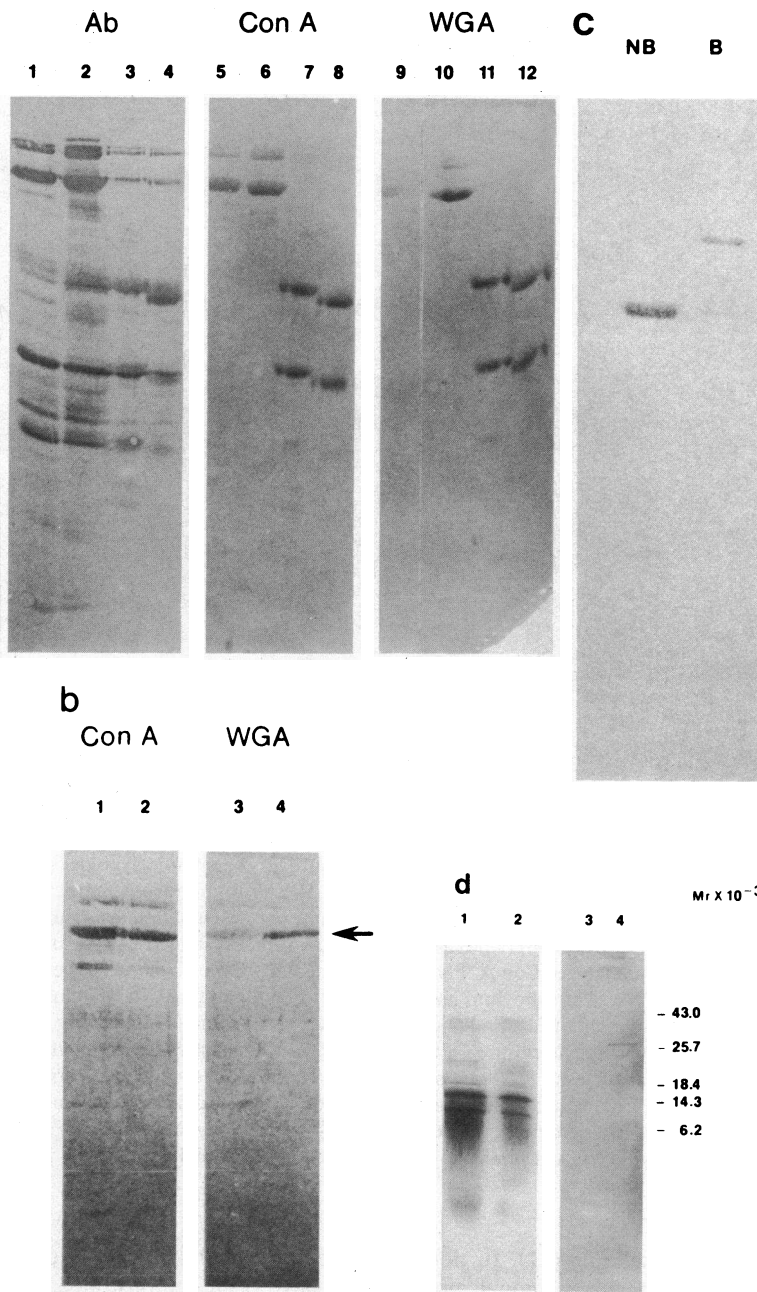

Figure 6. (a) Carbohydrate distribution profile of chymotryptic digests prepared from purified plasma and synovial fluid fibronectins. Plasma Fn, lanes 1, 3, 5, 7, 9, 11. Synovial fluid Fn, lanes 2, 4, 6, 8, 10, 12. Fragments not bound to gelatin-Sepharose (C-terminal derived) lane 1, 2, 5, 6, 9, 10 (21 μg protein). Fragments bound to gelatin-lanes 3, 4, 7, 8, 11, 12 (8 μg protein). Ab, all immunoreactive fragments identified with antifibronectin; Con A, Glycosylated fragments binding peroxidase labeled Con A. WGA, Fragments specifically reactive with peroxidase-labeled WGA. (b) WGA reactivity of chymotrypsin generated C-terminal (nongelatin binding) fragments of plasma Fn (27 μg protein) (lanes 1 and 3) and synovial fluid Fn (20 μg protein) (lanes 2 and 4) examined by lectin blotting of a 7% SDS-gel. Con A, peroxidase labeled Con A; WGA, peroxidase-labeled WGA. Arrow indicates strongly WGA reactive 140-kD synovial fluid Fn fragment. (c) Western blot of Fn C-terminal chymotryptic fragments separated by heparin-Sepharose chromatography. Blot stained with antifibronectin. NB, nonbinding fraction eluted with 0.1 M NaCl (140-kD fragment) B, bound fraction requiring 0.5 M NaCl for elution (160-kD fragment). (d) SDS-PAGE of *S. aureus* V8 proteolytic digests of plasma and synovial fluid Fn C-terminal chymotryptic fragments (b). (Lanes 1 and 3) Plasma Fn fragments; (lanes 2 and 4) Synovial fluid Fn fragments. (Lanes 1 and 2) Total protein stained with silver. (Lanes 3 and 4) Proteins transferred to nitrocellulose and stained with peroxidase WGA.

structure of synovial fluid Fn differs considerably from that of plasma Fn. Plasma Fn contains less neural hexose (2.8%), than does synovial fluid Fn (4.25%), whereas synovial fluid Fn contains less sialic acid, 0.7% vs. 1.2%. If both forms contain $\sim 1.5\%$ hexosamine and synovial fluid Fn contains $\sim 0.5\%$ *N*-acetylgalactosamine as estimated from GC analysis, then plasma Fn samples contain 5.5% carbohydrate, whereas the synovial fluid Fn contains 6.9%. Although the molecular masses of glycopeptides from both forms of Fn are consistent with biantennary N-linked carbohydrate units (10), synovial fluid glycopeptides appear somewhat smaller than glycopeptides derived from plasma Fn or transferrin and have a mean apparent 2,400 M_r . These data demonstrate four N-linked biantennary carbohydrate chains per plasma Fn monomer and are consistent with existing reports in the literature (22). Synovial fluid Fn appears to have at least one more carbohydrate

unit per monomer. In addition, synovial fluid Fn has a significant degree of O-glycosylation. O-glycosylation has recently been demonstrated on amniotic fluid Fn and to a minor degree on plasma Fn (23).

A population of undersialyated side chains in synovial fluid Fn may be responsible for the somewhat lower molecular mass exhibited by synovial fluid Fn glycopeptides (Fig. 6 b). Reduced sialylation of synovial fluid fibronectin has been suggested by the electrophoretic data of Zardi (24) and is consistent with data obtained for Fn secreted by fibroblasts in culture (11) and isolated from amniotic fluid (13).

The lack of fucose suggests that synovial fluid Fn is not entirely typical of "cellular" Fn. This is consistent with its synthesis from differentiated adult tissue since it is now felt that fucosylated cellular Fn is a product of fetal and tumor tissue (25).

Differences in Fn carbohydrate side chain structure are also demonstrated by their reactivity with a panel of lectins. Fn isolated from synovial fluid reacts more intensely with WGA and PNA than does normal plasma Fn. This difference is not a generalized property of fibronectins produced by patients with rheumatic disease since plasma Fn from a patient with RA shows markedly reduced WGA and PNA binding compared to simultaneously isolated synovial fluid Fn (Fig. 3 *b* and *c*).

Lectin binding patterns of Fn produced by cultured synoviocytes resemble those of synovial fluid Fn, demonstrating intense reactivity to WGA and PNA when compared to plasma Fn (Fig. 4). These data suggest that the carbohydrate composition of synovial fluid Fn resembles that of Fn secreted by synoviocytes, and thus provide further evidence for the local production of synovial fluid Fn. Similar carbohydrate group reactivities on synovial fluid Fn and Fn secreted by synovial fibroblasts in vitro also suggest that the enhanced PNA/WGA reactivity of Fn recovered from synovial fluid is not due solely to postsecretory modification of the molecule by glycosidic enzymes secreted by synovial fluid leukocytes (26).

Fn glycopeptides produced from synovial fluid Fn comigrate with the major Fn glycopeptide produced by synoviocytes in vitro, further suggesting similarity in the carbohydrate structures of these fibronectins (Fig. 1 *B* and *C*). In contrast, the higher molecular weight glycopeptide component consistently observed with plasma Fn preparations (Fig. 1 *A*) was not seen in preparations from synovial fluid or synoviocyte Fn. The microheterogeneity observed in the glycopeptide profile obtained from synovial fluid Fn may represent the contribution of other fibronectin producing cells in the joint such as macrophages (27), polymorphonuclear leukocytes (28), platelets (29), and endothelial cells (30).

Examination of lectin binding patterns of Fn chymotryptic digests show that carbohydrate side chain differences can be localized to specific domains of the molecule. Although chymotryptic digestion greatly reduces the PNA reactivity of the resultant synovial fluid Fn fragments, faint reactivity does appear on the gelatin binding fragments. This suggests maximal PNA activity requires intact synovial fluid Fn monomer and that the major reactive determinants are nonsialyated O-linked chains located on or near the gelatin binding N-terminal domains (Fig. 7, site 2). This is consistent with the studies of Nichols et al. (31) who demonstrated thermolysin sensitivity of monoclonal antibody AH8-28 binding. This antibody recognizes Gal β ₁₋₃GalNaC O-linked residues. A 22 amino acid sequence immediately C-terminal to the gelatin-binding domain (residue 591–610) encompasses a chymotryptic cleavage site and contains six serine residues as potential PNA-reactive O-glycosylation sites (Fig. 7, site 2).

Intact plasma Fn monomer displays weak WGA binding (Fig. 2). Following chymotryptic digestion, however, plasma Fn gelatin binding domains display strong WGA reactivity. This suggests that the heavily glycosylated gelatin binding domains (32) are not themselves responsible for differences in WGA binding and that a steric effect at the gelatin binding domain, central domain junction may interfere with WGA binding in the intact plasma Fn monomer under the conditions of this study (Fig. 7, site 1).

Recent studies have shown that variations in collagen binding affinity may be the result of alterations in glycosylation (33). We have previously shown that Fn isolated from inflammatory synovial fluid demonstrates reduced binding to gelatin

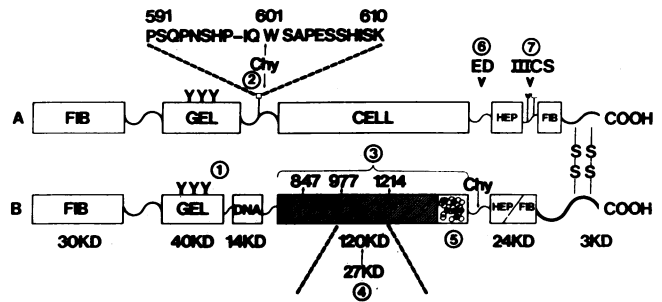

Figure 7. Model of fibronectin demonstrating major structural features and glycosylation heterogeneity. FIB, GEL, DNA, CELL, HEP indicate major domains. The approximate domain size is shown under each domain in kilodaltons. Y, N-linked oligosaccharide; O, O-linked oligosaccharide; r, sialyated N-linked oligosaccharide. Chy, chymotrypsin cleavage site. (1) Approximate location of conformation-dependent inhibition of WGA reactivity in plasma Fn. Plasma Fn gel binding domains acquire WGA positivity after chymotryptic cleavage (see Fig. 6 *a*). (2) Approximate location of conformation dependent PNA reactive site on synovial fluid Fn. This chymotrypsin sensitive region (residue 601–602) (36) is located in a 22 amino acid sequence containing six serine residues as potential O-glycosylation sites. (3) 140 kD nonheparin binding chymotryptic fragment localized to Fn “B” chain. (4) 27 kD WGA reactive fragment. Sialyated N-linked oligosaccharide (r) is potentially located at residue 847, 977, or 1214 (37). (5) Nonglycosylated 20 kD domain containing the RGD sequence. (6) ED represents extra domain found in cellular fibronectins. (7) IICS represents a variable region generated by RNA splicing which contains an O-linked and N-linked oligosaccharide chain.

that was in part attributed to posttranslational proteolytic changes (8). Altered glycosylation at or near the gelatin binding domain may contribute to differences in gelatin binding observed between plasma and synovial fluid Fn.

The responses of WGA and PNA reactivity on specific chymotryptic fragments to neuraminidase treatment suggest that at least two mechanisms are responsible for glycosylation heterogeneity between plasma and synovial fluid Fn (see Fig. 5). The low level of PNA reactivity displayed by plasma Fn appears to be due to interference with Gal β ₁₋₃GalNaC binding by the terminal sialic acid moiety of the oligosaccharide side chain on the gel-binding fragment (Fig. 7, site 2). Neuraminidase treatment of plasma Fn thus restores its PNA reactivity. Since synovial fluid Fn contains less total sialic acid, reduced sialylation of some of the O-linked carbohydrate side chains may be responsible for the intense PNA reactivity of synovial fluid fibronectins.

The difference in WGA reactivity localized to a 27-kD fragment derived from a 140-kD synovial fluid Fn C-terminal fragment (Fig. 6 *a-d*; Fig. 7 site 3). The WGA reactivity of the synovial fluid Fn C-terminal fragment was reduced by neuraminidase and was completely blocked by sialic acid; therefore, a sialic acid containing oligosaccharide must be responsible for the WGA reactivity of the synovial fluid Fn C-terminal fragment. This 140-kD synovial fluid Fn fragment (Fig. 6 *b*) did not bind to heparin (Fig. 6 *c*), and thus is devoid of the 24-kD C-terminal Hep/Fib domain (34) (Fig. 7). This 140-kD fragment has subsequently been shown to be derived from the fibronectin B chain (35). Since the cell binding 15–23-kD fragment located at the extreme C-terminal end of the 140-kD fragment (Fig. 7, site 5) is not glycosylated (36), the WGA

reactive oligosaccharide must be located on a 27-kD fragment (Fig. 6 d) minimally 60–70 kD from the C-terminal end of the synovial fluid fibronectin B chain (Fig. 7, site 4) and may involve potential N-linked glycosylation sites at residues 847, 977, and 1214 (37).

Our 140-kD fragment has properties similar to a 125-kD chymotryptic fragment described by Hormann et al. (36). The 125-kD fragment did not bind to gelatin, was not retained by heparin-Sepharose, contained carbohydrate and demonstrated WGA dependent binding to macrophage membranes that was inhibited by sialic acid. Since the actual cell binding region of Fn present on the C-terminal 23-kD fragment of the 125-kD fragment does not contain carbohydrate, the authors hypothesized that a sialic acid containing oligosaccharide on the N-terminal 95-kD section of the 125-kD fragment could modulate the cell binding activity of the 23-kD section. Interestingly, the intense WGA binding of our synovial fluid Fn C-terminal fragment is mediated by a sialic acid, containing oligosaccharide adjacent to the cell binding region.

It is thought that a major function of glycosylation is to protect the protein from enzymatic digestion (32, 38). Despite the presence of proteases in the inflamed joint, synovial fluid Fn has been shown to be largely intact (5, 8, 39, 40). Moreover, timed plasmin digests of plasma and synovial fluid Fn have shown that a synovial fluid Fn 190-kD fragment derived from the B chain shows enhanced resistance to proteolysis compared with plasma Fn (8). The enhanced WGA reactivity of the 140-kD B chain fragment derived from synovial fluid Fn may represent a difference in glycosylation responsible for its resistance to proteolysis.

We have demonstrated differences in carbohydrate composition between plasma and synovial fluid Fn. It should be noted that we have only studied patient material and cannot state with certainty that normal synovial Fn shares these properties. These differences, however, strengthen the argument for the local origin of synovial fluid Fn in inflamed joints and may help to explain its structural integrity and the regulation of its function in the inflammatory environment.

Acknowledgments

The authors wish to thank Barbara J. Diamond for photography assistance and Ann Marchesiello for preparation of the manuscript.

Supported in part by grants from the Kroc Foundation and the Arthritis Foundation, New York Chapter.

References

1. Carsons, S., M. W. Mosesson, and H. S. Diamond. 1981. Detection and quantitation of fibronectin in synovial fluid from patients with rheumatic disease. *Arthritis Rheum.* 24:1261–1267.
2. Lu-Steffes, M., A. J. Iammartino, F. R. Schmid, C. W. Castor, L. Davis, R. Enthwhistle, and B. Anderson. 1982. Fibronectin in rheumatoid and non-rheumatoid arthritic synovial fluid cryoproteins. *Ann. Clin. Lab. Sci.* 12:178–185.
3. Scott, D. L., M. Farr, A. P. Crockson, and K. W. Walton. 1982. Synovial fluid and plasma fibronectin levels in rheumatoid arthritis. *Clin. Sci.* 62:71–76.
4. Clemmensen, I., and R. B. Andersen. 1982. Different molecular forms of fibronectin in rheumatoid synovial fluid. *Arthritis Rheum.* 25:25–31.
5. Carnemolla, B., M. Cutolo, P. Castellani, E. Balza, S. Raffanti,

and L. Zardi. 1984. Characterization of synovial fluid fibronectin from patients with rheumatic diseases and healthy subjects. *Arthritis Rheum.* 27:913–921.

6. Laviertes, B. B., S. E. Carsons, H. S. Diamond, and R. S. Laskin. 1985. Synthesis, secretion, and deposition of fibronectin in cultured human synovium. *Arthritis Rheum.* 28:1016–1026.

7. Scott, D. L., J. P. Delamere, and K. W. Walton. 1981. The distribution of fibronectin in the pannus in rheumatoid arthritis. *Br. J. Exp. Pathol.* 62:362–368.

8. Carsons, S. E., B. B. Laviertes, H. S. Diamond, and S. G. Kinney. 1985. The immunoreactivity, ligand and cell binding characteristics of rheumatoid synovial fluid fibronectin. *Arthritis Rheum.* 28:601–612.

9. Vartio, T. 1983. Fibronectin: Multiple interactions assigned to structural domains. *Med. Biol.* 61:213–295.

10. Balian, G., E. Crouch, E. M. Click, W. G. Carter, and P. Bornstein. 1979. Comparison of the structures of human fibronectin and plasma cold-insoluble globulin. *J. Supramol. Struct.* 12:505–516.

11. Wagner, D. D., R. Ivatt, A. T. Destree, and R. O. Hynes. 1981. Similarities and differences between the fibronectins of normal and transformed hamster cells. *J. Biol. Chem.* 256:11708–11715.

12. Pande, H., J. Corkill, R. Sailor, and J. E. Shively. 1981. Comparative structural studies of human plasma and amniotic fluid fibronectins. *Biochem. Biophys. Res. Commun.* 101:265–272.

13. Ruoslahti, E., H. Jalanko, D. E. Comings, A. M. Neville, and D. Raghavan. 1981. Fibronectin from human germ cell tumors resembles amniotic fluid fibronectin. *Int. J. Cancer.* 27:763–767.

14. Slomiany, A., E. Zdebska, and B. Slomiany. 1984. Structures of the neutral oligosaccharides isolated from A-active human gastric mucin. *J. Biol. Chem.* 259:14743–14749.

15. Warren, L. 1959. The thiobarbituric acid assay of sialic acids. *J. Biol. Chem.* 234:1971–1975.

16. Dubois, M., K. S. Gilles, K. J. Hamilton, P. A. Rebers, and F. Schmidt. 1956. Colorimetric method for determination of sugars and related substances. *Anal. Chem.* 28:350–356.

17. Laemmli, U. K. 1970. Cleavage of structural proteins during the assembly of the head of bacteriophage T4. *Nature (Lond.)* 227:680–685.

18. Towbin, H., T. Staehelin, and T. Gordon. 1979. Electrophoretic transfer of proteins from polyacrylamide gels to nitrocellulose sheets: procedure and some applications. *Proc. Natl. Acad. Sci. USA.* 76:4350–4354.

19. Nicolson, G. L., and T. Irimura. 1984. Estimating glycoprotein carbohydrate chain structures by lectin reactivities in polyacrylamide gels. *Biol. Cell.* 51:157–164.

20. Lis, H., and N. Sharon. 1977. Lectins: Their chemistry and application to immunology. In *The Antigens*. M. Sela, editor. IV:429–529. Academic Press, New York.

21. Schwartzbauer, J., J. W. Tamkun, I. R. Laemischka, and R. O. Hynes. 1983. Three different fibronectin mRNAs arise by alternative splicing within the coding region. *Cell.* 35:421–431.

22. Fukuda, M., S. B. Lavery, and S. I. Hakomori. 1982. Carbohydrate structure of hamster plasma fibronectin. *J. Biol. Chem.* 257:6856–6860.

23. Krusius, T., M. Fukuda, A. Dell, and E. Ruoslahti. 1986. Structure of the carbohydrate units of human amniotic fluid fibronectin. *J. Biol. Chem.* 260:4110–4116.

24. Carnemolla, B., P. Castellani, M. Cutolo, L. Borsi, and L. Zardi. 1984. Lack of sialic acid in synovial fluid fibronectin. *FEBS (Fed. Eur. Biochem. Soc.) Lett.* 171:285–288.

25. Matsuura, H., and S. Hakomori. 1985. The oncofetal domain of fibronectin defined by monoclonal antibody FDC-6: Its presence in fibronectins from fetal and tumor tissues and its absence in those from normal adult tissues and plasma. *Proc. Natl. Acad. Sci. USA.* 82:6517–6521.

26. Schauer, R., M. Wember, and H. Tschesche. 1984. Isolation and characterization of an oligosaccharide and glycoprotein-specific sialidase from human leukocytes. *Hoppe-Seyler's Z. Physiol. Chem.* 365:419–426.

27. Alitalo, K., T. Hovi, and A. Vaheri. 1980. Fibronectin is produced by human macrophages. *J. Exp. Med.* 151:602-613.
28. Menard, C., A. D. Beaulieu, M. Audette, J. Corbeil, and L. Latullippe. 1985. Studies on fibronectin in inflammatory vs noninflammatory polymorphonuclear leukocytes of patients with rheumatoid arthritis. II. Synthesis and release of fibronectin in vitro. *Clin. Exp. Immunol.* 60:347-354.
29. Zucker, M. B., M. W. Mosesson, M. Broekman, and K. L. Kaplan. 1979. Release of platelet fibronectin (cold-insoluble globulin) from alpha granules induced by thrombosis or collagen. Lack of requirement for plasma fibronectin in ADP-induced platelet aggregation. *Blood.* 54:8-12.
30. Clark, R. A., J. H. Quinn, H. J. Winn, J. M. Lanigan, P. Dellapella, and R. B. Colvin. 1982. Fibronectin is produced by blood vessels in response to injury. *J. Exp. Med.* 156:646-651.
31. Nichols, E. J., B. A. Fenderson, W. G. Carter, and S. Hakomori. 1986. Domain-specific distribution of carbohydrate in human fibronectin and the transformation-dependent translocation of branched type 2 chain defined by monoclonal antibody C6. *J. Biol. Chem.* 261:11295-11301.
32. Bernard, B. A., K. M. Yamada, and K. Olden. 1982. Carbohydrates selectively protect a specific domain of fibronectin against proteases. *J. Biol. Chem.* 257:8549-8554.
33. Zhu, B. C. R., and R. A. Laine. 1985. Polylysosamine glycosylation on human fetal placental fibronectin weakens the binding affinity of fibronectin to gelatin. *J. Biol. Chem.* 260:4041-4045.
34. Hayashi, M., and K. M. Yamada. 1983. Domain structure of the carboxy-terminal half of human plasma fibronectin. *J. Biol. Chem.* 258:3332-3340.
35. Czop, J. K., J. L. Kadish, D. M. Zepf, and K. F. Austin. 1985. Identification with monoclonal antibodies of different regions of human plasma fibronectin, including that which interacts with human monocyte fibronectin receptors. *Immunology.* 54:407-417.
36. Hormann, H., H. Richter, and V. Jelinic. 1984. Evidence for a cryptic lectin site in the cell-binding domain of plasma fibronectin. *Hoppe-Seyler's Z. Physiol. Chem.* 365:517-524.
37. Skorstengaard, K., M. S. Jensen, P. Sahl, T. E. Petersen, and S. Magnusson. 1986. Complete primary structure of bovine plasma fibronectin. *Eur. J. Biochem.* 161:441-453.
38. Olden, K., B. Bernard, S. L. White, and J. B. Parent. 1982. Function of the carbohydrate moieties of glycoproteins. *J. Cell. Biochem.* 18:313-335.
39. Vartio, T., A. Vaheri, R. Von Essen, H. Isomkai, and S. Stenman. 1981. Fibronectin in synovial fluid and tissue in rheumatoid arthritis. *Eur. J. Clin. Invest.* 11:207-212.
40. Scott, D. L., S. D. Carter, J. S. Coppock, M. Robinson, and K. W. Walton. 1985. Differences between plasma and synovial fluid fibronectin. *Rheum. Int.* 5(2):49-54.