

Neural Control of the Lower Esophageal Sphincter INFLUENCE OF THE VAGUS NERVES

Satish Rattan, Raj K. Goyal

J Clin Invest. 1974;54(4):899-906. <https://doi.org/10.1172/JCI107829>.

Research Article

We performed studies in the opossum to define the influence of the vagi in the control of lower esophageal sphincter (LES) function. Bilateral vagotomy caused transient sphincter hypertension which was prevented by phentolamine and by atropine. Stimulation of the peripheral end of vagus, after bilateral cervical vagotomy, caused relaxation of the LES over a wide range of frequency and intensity of electrical stimulation. The relaxation was less marked at the lower frequencies of stimulation, and atropine treatment did not enhance this relaxation. In other experiments, atropine treatment reversed the rise in gastric (fundic) pressure with the vagal stimulation, but atropine did not enhance the degree of LES relaxation. Stimulation of the central end of the vagus caused an increase in LES pressure due to a centrally mediated reflex; the efferents for this motor response were not present in the vagi, as the reflex contraction persisted after bilateral vagotomy. The LES contraction with the stimulation of the vagal afferents was antagonized by phentolamine as well as by atropine. These studies suggest that: (a) the vagi do not mediate any cholinergic excitatory influences to the LES and the vagal influence of the sphincter is entirely inhibitory; (b) the vagi carry afferent fibres for a centrally mediated neural reflex which contracts the LES, but the efferent path of this reflex arc does not [...]

Find the latest version:

<https://jci.me/107829/pdf>



Neural Control of the Lower Esophageal Sphincter

INFLUENCE OF THE VAGUS NERVES

SATISH RATTAN and RAJ K. GOYAL

From the Department of Internal Medicine, Baylor College of Medicine, Houston, Texas, and the University of Texas Southwestern Medical School, Dallas, Texas 75235

ABSTRACT We performed studies in the opossum to define the influence of the vagi in the control of lower esophageal sphincter (LES) function. Bilateral vagotomy caused transient sphincter hypertension which was prevented by phentolamine and by atropine. Stimulation of the peripheral end of vagus, after bilateral cervical vagotomy, caused relaxation of the LES over a wide range of frequency and intensity of electrical stimulation. The relaxation was less marked at the lower frequencies of stimulation, and atropine treatment did not enhance this relaxation. In other experiments, atropine treatment reversed the rise in gastric (fundic) pressure with the vagal stimulation, but atropine did not enhance the degree of LES relaxation. Stimulation of the central end of the vagus caused an increase in LES pressure due to a centrally mediated reflex; the efferents for this motor response were not present in the vagi, as the reflex contraction persisted after bilateral vagotomy. The LES contraction with the stimulation of the vagal afferents was antagonized by phentolamine as well as by atropine. These studies suggest that: (a) the vagi do not mediate any cholinergic excitatory influences to the LES and the vagal influence of the sphincter is entirely inhibitory; (b) the vagi carry afferent fibres for a centrally mediated neural reflex which contracts the LES, but the efferent path of this reflex arc does not lie in the vagi.

INTRODUCTION

The role of the vagi in the control of the lower esophageal sphincter (LES)¹ function is poorly understood

Part of this work was presented before the Annual Meeting of the American Federation for Clinical Research, Atlantic City, N. J., on 5 May 1974.

Received for publication 6 December 1973 and in revised form 10 June 1974.

¹Abbreviations and trivial names used in this paper:

(1). Some observers have reported that electrical stimulation of the peripheral end of the vagus, after cervical vagotomy, may cause either LES relaxation or contraction depending upon the frequency and intensity of vagal stimulation and the existing tone of the cardia at the time of stimulation (2-5), while others have observed a sequence of inhibition followed by contraction (2, 6). Current views on the subject are vague (7-11), but most observers appear to accept the idea that the vagi can exert both inhibitory and excitatory influence on the LES. Moreover, lesions in the vagal excitatory efferents to the LES have been implicated in the pathogenesis of LES incompetence (12, 13) and achalasia (14).

Because of the clinical importance of LES competence and relaxation, we performed studies to define more clearly the influence of the vagi on the LES. First, we investigated the effect of bilateral vagotomy on LES pressure. Second, we studied the effect of electrical stimulation of the peripheral end of the vagus after bilateral vagotomy, using a wide range of frequency (F) and intensity of stimulation. Third, we studied the effect of electrical stimulation of the central end of the vagus on the LES pressure.

METHODS

Studies were performed in 39 opossums (*Didelphis virginiana*) because the lower esophagus including the LES in this animal is composed of smooth muscle fibres, and this arrangement is similar to that found in man (15). Moreover, several recent studies have suggested that the neuro-hormonal control of the LES function in the opossum may

bethanechol, (2-hydroxypropyl)trimethylammonium chloride carbamate; edrophonium, ethyl(*m*-hydroxyphenyl)dimethylammonium bromide; F, frequency of the pulses of the stimulation; LES, lower esophageal sphincter; phentolamine, 2-[*N*-(*m*-hydroxyphenyl)-*p*-toluidinomethyl]imidazoline; phenylephrine, *l-m*-hydroxy- α -[(methylamino) methyl]benzyl alcohol hydrochloride.

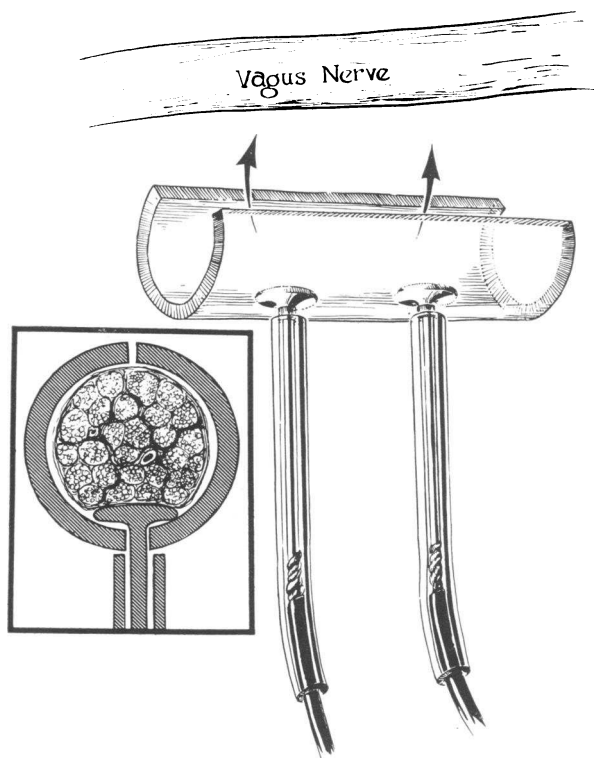

FIGURE 1 Diagrammatic presentation of the electrode used for vagal stimulation. The electrode was made from a 12-mm-long polyvinyl tubing (ID=2 mm, OD=4 mm). The tubing was split open along its longitudinal axis and two steel pins with heads (1.2 mm diameter) were made to pierce through it. The distance between the two stimulating points was 5 mm.

be similar to that in man (10). The animals were of either sex, and they weighed from 2.5 to 5.1 kg. All studies were done in animals fasted for 12-16 h. The animals were anesthetized, and the pressures of the LES and the gastric fundus were measured manometrically as described elsewhere (16, 17). The length of the high pressure zone of the LES in different animals varied from 7 to 12 mm (mean=9.0±0.6, SE); the zenith of the pressure in the profile of the LES pressure was observed around the middle of the sphincter. The peak of the excursion, inspiratory or expiratory, at the zenith of the sphincter pressure was considered as the LES pressure, and the responses of this part of the sphincter are described in all of these studies. The changes in LES pressure are expressed as absolute values. However, in some experiments in which comparisons are made in the same group of animals, results are expressed as a percent change, for the sake of convenience.

The effect of vagotomy on the LES pressure was studied because the published reports give contradictory results. Recently it has been reported (18) that bilateral cervical vagotomy does not alter LES pressure. However, some previous studies (1) had reported that bilateral cervical vagotomy may cause temporary spasm of the LES. The vagi were exposed on either side in the neck through a 2-inch-long midline incision, which started below the level

of the laryngeal prominence. Each vagus² was identified as it lay in the carotid sheath, behind and in between the internal jugular vein and the common carotid artery. The identity of the vagus was confirmed by electrically stimulating the nerve, which produced bradycardia and cardiac arrest, depending upon the intensity of stimulation. The exposed vagus was then secured in two loops of thread which were tied, and the vagus was sectioned between them. The procedure was then repeated for the vagus on the other side, and the LES pressure was continuously monitored.

To study the effect of electrical stimulation, an electrode (Fig. 1) was placed around the vagus nerve. With this electrode there was no leakage of the electric current to the neighboring structures, and the nerve was kept from drying. Any leak of electric current due to a defective electrode was easily recognized, as it caused twitching of the neighboring muscles. Electrical stimulus was provided via these electrodes with a Grass stimulator (model S48, Grass instrument Co., Quincy, Mass.). The stimulus was monitored on one of the channels of the recorder which recorded the sphincter pressures. Square wave pulses of 0.5-8 ms were applied, in trains of 1-300 s, at frequencies of stimulation varying from 0.25 to 100 Hz, and current varying from 2 to 50 V.

An intravenous cannula was secured in place in one of the brachial or femoral veins. The cannula was kept open by rinsing it with 2,000 U of heparin in 0.2 ml and by flushing it periodically with sterile 0.15 N saline. Drugs were injected via the intravenous cannula. After each injection the cannula was flushed with 2 ml of normal saline.

The following drugs were used: atropine sulfate (Eli Lilly and Co., Indianapolis, Ind.); bethanechol (2-hydroxypropyl)trimethylammonium chloride carbamate, Merck, Sharp & Dohme, West Point, Pa.); edrophonium (ethyl(*m*-hydroxyphenyl)dimethylammonium bromide, Roche Laboratories, Nutley, N. J.); phenylephrine (*l*-*m*-hydroxy- α -[(methylamino)methyl]benzyl alcohol hydrochloride, Robinson Laboratory, Inc., San Francisco, Calif.); phentolamine (2-[*N*-(*m*-hydroxyphenyl)-*p*-toluidinomethyl]imidazoline, Ciba Corporation, Summit, N. J.).

Atropine sulfate (30 μ g/kg) in three vagotomized animals caused an initial fall in the LES pressure from 34±0.7 mm Hg to 23.3±3.3 mm Hg ($P < 0.05$). However, after 8-10 min the LES pressures returned to preinjection values; the LES pressure at 10 min after atropine administration was 33.7±2.0, which was not significantly different from the preinjection value ($P > 0.05$). Although the sphincter pressure returned to normal levels, effective cholinergic antagonism was present even after 45 min of atropine administration, as indicated by complete antagonism of a maximal effective dose of bethanechol (20 μ g/kg). Bethanechol in the dose of 20 μ g/kg produced 139±10.5% increase in the LES pressure in three animals, but a further increase in the dose of bethanechol to 40 μ g/kg produced only a 95.7±7.7% increase in the sphincter pressure. Moreover, 30 μ g/kg of atropine completely antagonized the increase in LES pressure caused by 80 μ g/kg edrophonium, a cholinesterase inhibitor. Phentolamine (1 mg/kg) also caused an

²The sympathetic trunk lies just medial to the vagus. At this level, vagus nerves have already given off superior laryngeal branches, which cause swallowing upon stimulation. We observed that the electrical stimulation of the cervical sympathetic trunk produces no change in the sphincter pressure.

initial fall in LES pressure (17), which then returned to normal level, even though the effect of maximal effective dose of 50 $\mu\text{g}/\text{kg}$ of phenylephrine, an alpha adrenergic agonist, was antagonized at 30 min after the administration of phentolamine. All studies were performed within 30 min of the administration of phentolamine.

RESULTS

Effect of cervical vagotomy on the LES pressure

Influence of unilateral vs. bilateral vagotomy. Unilateral vagotomy did not alter LES pressure during the 10-min period of observation. Section of the second vagus caused a prompt increase in the LES pressure by $113.8 \pm 26.9\%$ (absolute increase in pressure was 26.0 ± 6.1 mm Hg) at 2 min after the section of the second vagus. Fig. 2 summarizes the mean change in LES pressures before and after the section of the second vagus in four animals. Note that the sphincter pressures returned towards normal at 4 min, although some elevation in the LES pressure persisted over 10 min after vagal section. The LES pressures in these four animals were not different from the prevagotomy level at 30 min and 60 min after vagotomy. The percent change was $+11.4 \pm 1.8\%$ at 30 min and $+16.3 \pm 4.5\%$ at 60 min ($P > 0.05$). Chronic effects of vagotomy on the sphincter pressure were not studied.

Influence of phentolamine and atropine pretreatment. To define the mechanism of the transient LES hypertension associated with bilateral vagotomy, we studied the effect of phentolamine and atropine on the LES spasm.

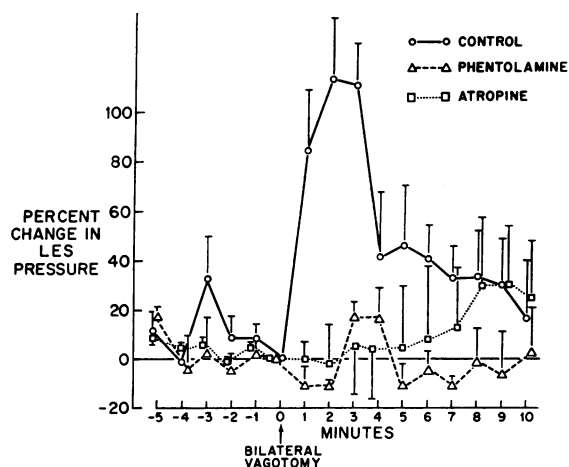

FIGURE 2 Effect of phentolamine and atropine pretreatment on LES response to bilateral vagotomy. Control response was obtained in four animals and the effect of phentolamine (1 mg/kg) and atropine (30 $\mu\text{g}/\text{kg}$) was studied in three animals each. The LES pressures were measured every minute and expressed as percent of the value at 0-time when the second vagus was cut. Each point shows mean value and 1 SE. Note the lack of LES hypertension after phentolamine or atropine pretreatment.

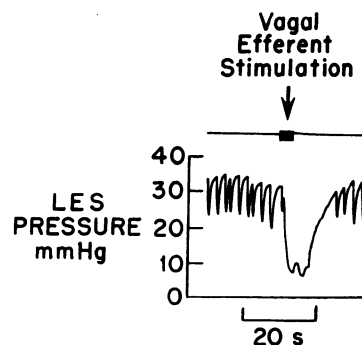

FIGURE 3 A typical response of the LES with stimulation of the peripheral end of the vagus. The peripheral end of the left vagus was stimulated, after bilateral cervical vagotomy, with stimulus of 10 V, square waves of 0.5 ms duration at 10 Hz for 4 s. Note a fall in LES pressure a little after the onset of the stimulus. The LES relaxation lasted longer than the vagal stimulation. Also note that after the relaxation was over, the LES pressure returned to prestimulation base-line pressure.

Phentolamine (1 mg/kg) was administered 10 min before bilateral vagotomy because by that time the LES pressure had returned to the preinjection level. Atropine (30 $\mu\text{g}/\text{kg}$) was also administered 10 min before vagotomy to avoid acute effects of intravenous bolus injection of atropine.

As shown in Fig. 2, phentolamine as well as atropine pretreatment in three animals each prevented the LES spasm with bilateral cervical vagotomy. The effect of phentolamine suggests that the LES spasm is not due to irritation of cholinergic motor fibres in the vagus, as had been suggested (1, 4). Our studies, on the other hand, suggest that the LES hypertension associated with bilateral vagotomy may be due to sudden imbalance between alpha adrenergic excitatory influences and the vagal inhibitory effect.

Effect of the stimulation of the peripheral end of the vagus on LES pressure

General observations. A typical response of the LES to vagal stimulation with 10 V, frequency of 10 Hz, square wave impulses of 0.5 ms applied for 4 s is shown in Fig. 3. The LES pressure fell with vagal stimulation, and after the relaxation was over, the sphincter pressure returned to the resting level.³

³ We have also observed that on vagal stimulation the upper one-third of the LES shows relaxation followed by after-contraction, so that the LES pressure transiently overshoots the resting LES pressure. The after-contraction of the upper part of the LES follows the sequence of peristaltic activity in the body of the esophagus, and it presumably represents the mixture of the esophageal-body and the sphincteric muscles (18).

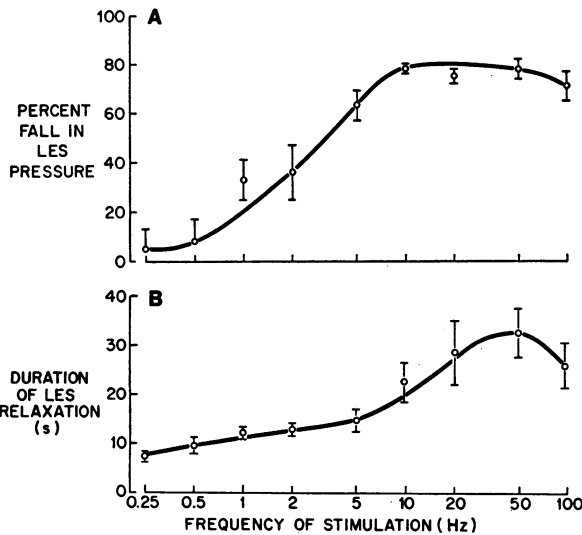

FIGURE 4 Effect of frequency of stimulation of the vagus nerve on LES. Peripheral end of one of the vagus nerves was stimulated in animals who had bilateral cervical vagotomy. Stimulus pulses were square waves at 10 V, 0.5 ms duration with a train duration of 4 s. The frequency was varied from 0.25–100 Hz. These studies were done in five animals. The frequency of stimulus was randomized, and the successive stimuli were separated by 2–3 min. Each point represents mean \pm 1 SE. (A) shows that the degree of LES relaxation increases with increasing frequency of stimulation. Note that none of the frequencies of stimulation caused a contraction of the LES. The maximal fall in the LES pressure occurred at a frequency of 10 Hz. (B) shows that the duration of relaxation also varied with frequency of stimulation.

Influence of the frequency, intensity, train length, and pulse duration of vagal stimulation. It has been suggested that vagal stimulation with certain frequen-

cies and intensities causes LES relaxation and that stimulation at other frequencies may reveal its excitatory influence on the LES (1, 3). To test this hypothesis, we examined the effect of various frequencies, intensities, train length, and pulse duration of vagal stimulation on the LES pressure.

Five animals were tested with stimuli of various frequencies and of 10 V with square waves of 0.5 ms and train duration of 4 s. The stimuli of the different frequencies were applied at random, and they were applied 2–3 min apart. Vagal stimulation at all of the frequencies of stimulation caused LES relaxation. The degree and duration of LES relaxation, however, varied with the different frequencies of stimulation (Fig. 4).

As shown in Fig. 5A, at a frequency of 10 Hz, square waves of 0.5 ms, and train duration of 4 s, the degree of LES relaxation was dependent upon the voltage of stimulus; none of the voltages of stimulation caused contraction of the LES. Peak LES relaxation was seen with 10 V. Increasing the voltage to 25 did not change the degree of LES relaxation.

The duration of the train of stimulus did not influence the LES response when other parameters were kept constant (Fig. 5B). However, the duration of LES relaxation always lasted longer than the duration of vagal stimulation, but it was directly related to the duration of the train of stimulation.

The pulse durations were varied from 0.5 through 8 ms. The other parameters were kept constant. The pulse duration of the stimulus did not influence the LES response either qualitatively or quantitatively (Fig. 5C), suggesting that in our preparation pulse duration of 0.5 ms produced maximal vagal stimulation.

Influence of atropine on the frequency response curve of the LES relaxation with vagal stimulation. The

TABLE I
Effect of Atropine (30 μ g/kg) on the Frequency Response Curves of the Effect of the Stimulation of the Peripheral End of the Vagus after Cervical Vagotomy in Five Animals

Frequency of stimulation	Initial LES pressure		P	LES pressure with vagal stimulation					
				Final pressure			Percent fall		
	Control	Atropine		Control	Atropine	P	Control	Atropine	P
Hz	mm Hg			mm Hg					
0.25	38.8 \pm 3.9	36.6 \pm 3.0	>0.05	33.8 \pm 3.3	33.3 \pm 2.4	>0.05	11.2 \pm 2.3	7.4 \pm 2.3	>0.05
0.5	36.0 \pm 2.0	38.2 \pm 3.6	>0.05	28.9 \pm 1.9	31.2 \pm 2.2	>0.05	20.2 \pm 2.7	16.1 \pm 2.8	>0.05
1	37.9 \pm 2.3	37.2 \pm 1.9	>0.05	24.3 \pm 2.8	26.1 \pm 1.7	>0.05	35.7 \pm 4.7	29.1 \pm 3.7	>0.05
2	39.7 \pm 2.3	37.9 \pm 2.2	>0.05	16.0 \pm 2.8	18.8 \pm 1.6	>0.05	62.3 \pm 4.7	47.5 \pm 5.2	<0.05*
5	35.3 \pm 1.3	36.3 \pm 2.8	>0.05	7.1 \pm 0.7	11.2 \pm 1.7	<0.05*	81.9 \pm 1.8	68.3 \pm 4.4	<0.05*
10	34.0 \pm 1.8	33.0 \pm 1.5	>0.05	5.1 \pm 0.6	7.0 \pm 3.7	>0.05	85.0 \pm 1.5	77.8 \pm 2.6	<0.05*
20	36.5 \pm 2.2	33.2 \pm 3.6	>0.05	4.6 \pm 0.6	5.3 \pm 0.07	>0.05	87.4 \pm 1.4	83.7 \pm 2.4	>0.05
50	33.4 \pm 1.8	41.5 \pm 3.4	<0.05*	4.6 \pm 0.4	5.6 \pm 0.5	>0.05	86.2 \pm 0.9	85.4 \pm 1.7	>0.05

These values are mean \pm SEM of at least 15 observations.

* Statistically significant difference.

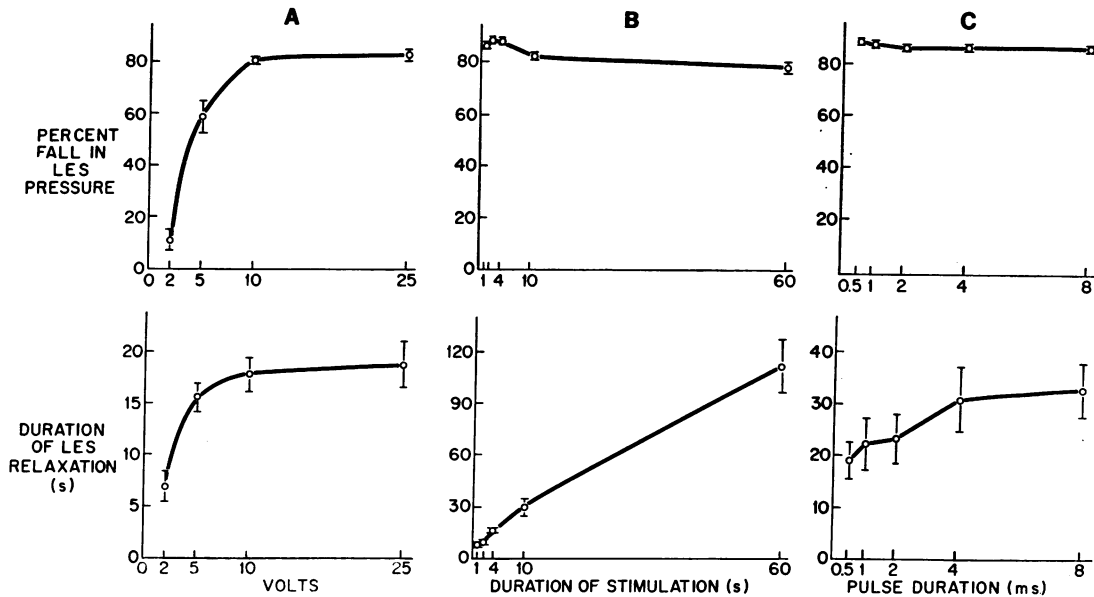

FIGURE 5 Effect of intensity, duration, and pulse duration of stimulation of the peripheral end of the vagus on the LES pressure. (A) shows the effect of varying the voltage of stimulation from 2-25 with square wave pulses of 0.5 ms duration, $F=10$ Hz, and train duration 4 s. Each point is mean ± 1 SE in six animals. Note that none of the voltages tested caused LES contraction; stimulation of 10 V produced maximal degree and duration of relaxation. (B) shows the effect of duration of train of stimulus. 1, 2, 4, 10, and 60 s of stimuli were tested with square wave of 0.5 ms, $F=10$ Hz, 10 V. Note that duration of stimulation did not influence the degree of relaxation, but the duration of LES relaxation was directly related to the duration of stimulus. (C) shows the effect of different pulse durations with square wave of $F=10$ Hz, 10 V, and train lengths of 4 s.

degree of the LES relaxation with vagal stimulation could be the net response of both excitatory and inhibitory nerves. It appeared that the relatively small LES relaxation at the lower frequencies of stimulation could be due to greater participation of the cholinergic motor influences at these lower frequencies of stimulation. Therefore, we examined the LES response to vagal stimulation after cholinergic antagonism with atropine. Table I summarizes the LES response to vagal stimulation during the control period and after atropine treatment in a group of five animals at various frequencies of stimulation. Atropine treatment did not enhance the degree of LES relaxation with vagal stimulation at any of the frequencies examined. On the contrary, at some of the frequencies of stimulation, atropine treatment significantly antagonized LES relaxation with vagal stimulation.

Comparison of the response of the gastric (fundic) and the LES pressure with vagal stimulation before and after atropine treatment. We used atropine in the maximal effective dose as shown by antagonism of the maximal doses of bethanechol and edrophonium. However, there was no assurance that this dose would ef-

fectively antagonize responses to actual cholinergic nerve stimulation in the opossum. Initial studies of fundic pressure responses to vagal stimulation showed that they might provide us with a model for cholinergic nerve-stimulated responses, as the fundic pressure increased with vagal stimulation and was fully antagonized by atropine. The increase in fundic pressure was consistently observed with stimulation with a high intensity current (50 V). Therefore, we reinvestigated the LES response, along with the fundic pressure response (as control) before and after treatment with atropine in three animals.

Vagal stimulation during the control period caused the fundic pressure to increase from 5.9 ± 0.2 mm Hg to 8.7 ± 0.3 mm Hg ($P < 0.05$), but it caused the LES pressures to decrease from 32.8 ± 2.9 to 5.1 ± 0.8 mm Hg. After atropine treatment, the basal fundic and the basal LES pressures were unchanged (Fig. 6). However, atropine treatment reversed the rise in the fundic pressure with vagal stimulation to a fall. On the other hand, the degree of LES relaxation with vagal stimulation was not enhanced by atropine (Fig. 6).

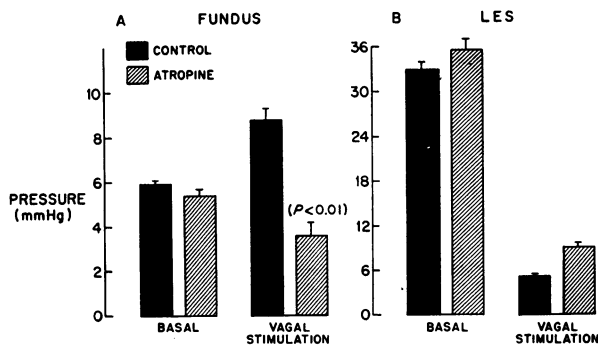

FIGURE 6 Effect of atropine on the gastric (fundic) pressure and the LES pressure in response to a high intensity (50 V) vagal stimulation. The bar heights represent the mean values of 14–17 observations in three animals. (A) Fundic pressure. Note that vagal stimulation caused a significant increase in the fundic pressure ($P < 0.05$). Atropine treatment did not alter the basal fundic pressure, but it reversed the increase in fundic pressure to a decrease in the fundic pressure ($P < 0.05$) with vagal stimulation. (B) LES pressure. Note that atropine did not significantly alter the basal pressure ($P > 0.05$). After vagal stimulation the LES pressure fell both during control period as well as after atropine treatment. Also note that atropine treatment did not enhance the degree of LES relaxation with vagal stimulation; on the contrary, atropine significantly antagonized the degree of the LES relaxation ($P < 0.05$).

Effect of stimulation of the central end of the vagus on the LES pressure

Influence of unilateral vagotomy. With one vagus intact, stimulation of the central end of the other vagus (with stimuli of 10 V, 50 Hz, pulse duration of 0.5 ms, and train duration of 4 s) caused a 21.9 ± 2.4 -mm Hg ($62.3 \pm 6.5\%$) increase in LES pressure in five animals ($n = 19$).

Influence of bilateral vagotomy. We initially thought that this increase in pressure with the stimulation of vagal afferents was mediated by the excitatory efferents in the second vagus which was intact. However, after the second vagus was also sectioned, stimulation of vagal afferents still caused LES contraction (Fig. 7); the mean increase in LES pressure was 17.9 ± 2.7 mm Hg ($53.1 \pm 9\%$). This increase was not significantly different from the increase in pressure with the other vagus intact ($P > 0.05$). These observations suggested that the efferent fibres of the reflex which mediate reflex LES contraction are not carried via the vagi.

Influence of atropine and phentolamine. To define the nature of the efferents which mediate LES contraction in response to afferent vagal stimulation, we investigated the effect of phentolamine and atropine on the reflex LES contraction after bilateral cervical vagotomy in seven animals. The resting LES pressures were 36.7 ± 2.5 , 38.7 ± 2.2 , and 38.1 ± 3.4 mm Hg after

bilateral vagotomy alone, after phentolamine, and after atropine treatment. These differences were not significant ($P > 0.05$). The LES contraction with the stimulation of the vagal afferents was significantly ($P < 0.05$) antagonized by phentolamine or by atropine treatment (Fig. 8).

DISCUSSION

These studies reveal that the vagi carry purely inhibitory efferents to the LES. They also carry afferent fibres for a centrally mediated reflex for LES contraction. We found no evidence of cholinergic excitatory efferents to the LES in the vagus.

The discrepancy between our results and those of previous observers who found the vagus to cause LES contraction (1–6) may be largely due to technical factors. In many older studies which reported contraction of the cardia with vagal stimulation, large (2–5 cm) esophagus-cardia balloons were used to monitor pressure (1, 3, 4, 6). Such large balloons are likely to measure simultaneously pressure from the stomach, LES, and body of the esophagus. The reported contraction of cardia in these studies may have been due to contraction of the fundus of the stomach and the body of the esophagus in response to vagal stimulation.

We did not look for cholinergic excitatory nerves to the LES outside the vagal pathway. There have been several studies on the LES muscle strips from the opossum, in which transverse strips of the LES muscle were stimulated by transmural stimulation (18, 19); they have not produced uniform results, however. Cohen and Green (19) report that LES muscle strips

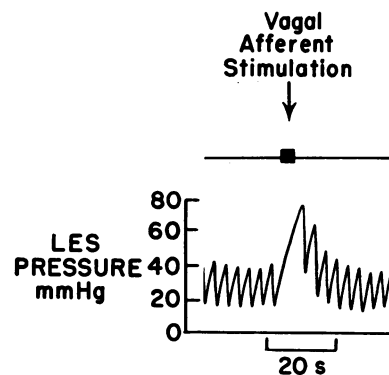

FIGURE 7 Effect of the stimulation of the central end of vagus after bilateral vagotomy. The central end of the vagus was stimulated with electrical stimuli of 10 V, 50 Hz, pulse duration of 0.5 ms, and train duration of 4 s. Note increase in sphincter pressure with vagal stimulation. This reflex contraction is mediated via an extravagal pathway, as both the vagi had been sectioned. Stimulation of the vagal afferent caused a transient apnea, but did not modify the esophageal or the gastric pressures.

show relaxation followed by contraction, whereas Christensen, Freeman, and Miller (18) report that LES muscle shows only relaxation with transmural stimulation. These differences may be related to selection of the "sphincter segment" and differences in the techniques of transmural stimulation and other factors. In any event, the results of transmural stimulation of the transverse muscle strips cannot be equated with those of vagal stimulation, because transmural stimulation will produce net results of the stimulation of the vagal nerve elements, sympathetic nerves as well as intramural nerves, which may not be connected with the extrinsic nerves. Studies to discriminate between the various excitatory and inhibitory neural fibres have not been done. Using a variety of pharmacologic agents, Lipshutz, Tuch, and Cohen have shown the existence of the cholinergic excitatory neurons to the LES of the opossum; they have also shown that gastrin acts via these cholinergic neurons to produce LES contraction (20). Our studies, however, reveal that if there are cholinergic neurons to the LES, they do not lie in the vagal pathway to the LES.

There are four important implications of these observations. First, current views (1, 9) on the mechanism of relaxation of the LES consider that it may be due to the inhibition of continuous excitatory activity in the vagal nuclei, to active inhibitory impulse sent to the LES, or to both. Our studies show that LES relaxation is due to active inhibitory impulses carried along the vagi to the LES. On the other hand, the view that LES relaxation is due to central vagal inhibition implies that the LES closure is maintained by the impulses arising in the vagal nuclei and that the LES opening is due to reduction in the number of these impulses carried via the vagus nerve (1). Since we found no evidence to suggest that vagus nerves exert a tonic motor influence on the LES, the hypothesis of the central inhibition becomes an unlikely one.

Second, based on the assumption that there is a cholinergic excitatory pathway to the LES in the vagi, lesions in this pathway have been implicated in the pathogenesis of disorders of the LES. It is proposed that the reduced vagal (excitatory) tone may be responsible for incompetent LES that are found in patients with reflux esophagitis (12, 13). On the other hand, preganglionic denervation in the vagal nuclei and vagal trunks has been proposed as the cause of the LES supersensitivity to postganglionic cholinergic stimulation with gastrin and cholinomimetic agents in achalasia (14, 21, 22). Our studies do not provide evidence to support the basic assumption of the above hypotheses. Our observations, however, support the view that lesions in the vagal afferents, which may

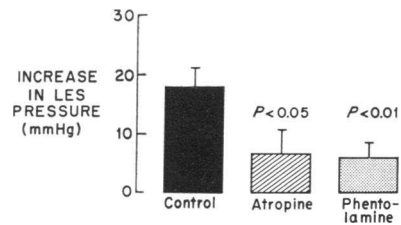

FIGURE 8 Effect of atropine and phentolamine pretreatment on the LES contraction caused by the stimulation of the central end of the vagus after bilateral vagotomy. Each panel represents mean \pm 1 SE of 13-14 observations. Note that the stimulation of the central end of the vagus after bilateral cervical vagotomy caused a 17.9 ± 2.7 -mm Hg increase in the LES pressure. This was significantly antagonized with atropine as well as with phentolamine treatment.

mediate reflex LES contraction, may be responsible for impaired adaptive responses of the LES found in patients with vagotomy (12). Lesions in the vagal efferent pathway, which is entirely inhibitory, may contribute to the impaired relaxation of the LES found in achalasia. Moreover, lesions in this inhibitory pathway to the LES may lead to supersensitivity to excitatory agents, such as gastrin and cholinomimetic agents, due to the lack of counter-regulatory influences of the inhibitory mechanism.

Third, these studies show that the efferents for the centrally mediated reflex contraction from the LES do not lie in the vagus as suggested by some observers (13), but instead they may lie in the sympathetic pathway. The adrenergic excitatory pathway to the LES, however, does not lie in the cervical sympathetic trunks, as the stimulation of the cervical sympathetic trunk was without effect on the LES. These excitatory efferents for the LES may lie in the lower thoracic sympathetic outflow.

Fourth, atropine has been reported to antagonize the reflex contraction on the LES in response to abdominal compression and also to cause a decrease in the LES pressure (13, 23). This effect has been interpreted to indicate antagonism of the vagal cholinergic motor influence on the LES (13). Our studies show that atropine may act to antagonize the extravagal excitatory pathway to the LES. This may be due to the presence of cholinergic link in the adrenergic excitatory pathway or a nonspecific depressant action of atropine on the adrenergic excitatory pathway to the LES. In any event, these observations illustrate that the effect of atropine on the LES should not be equated with antagonism of the vagal pathway (13).

It is of some interest to note that atropine treatment showed some antagonism of LES relaxation with the stimulation of the peripheral end of the vagus. This effect of atropine may be due to antagonism of the

ganglionic transmission in the vagal inhibitory pathway.⁴

ACKNOWLEDGMENTS

We wish to thank Dr. Norman Weisbrodt and Dr. John S. Fordtran for helpful suggestions and criticisms and Jean Harber for typing the manuscript.

These studies were supported in part by the Southwest Medical Foundation, Dallas, Texas, University of Texas System Regents Appropriations for Organized Research, and U. S. Public Health Service Research grant no. 1 RO1 AM 16816 from the National Institutes of Arthritis, Metabolism and Digestive Diseases.

REFERENCES

1. Ingelfinger, F. J. 1958. Esophageal motility. *Physiol. Rev.* **38**: 533-584.
2. Cannon, W. B. 1911. *The Mechanical Factors of Digestion*. Longman's, Inc., New York.
3. Veach, H. O. 1925. Studies on the innervation of smooth muscle. I. Vagus effects on the lower end of the esophagus, cardia and stomach of the cat and stomach and lung of the turtle in relation to Wedensky inhibition. *Am. J. Physiol.* **71**: 229-264.
4. Carlson, A. J., T. E. Boyd, and J. F. Percy. 1922. Studies on the visceral sensory nervous system. XIII. The innervation of the cardia and the lower end of the esophagus in mammals. *Am. J. Physiol.* **61**: 14-41.
5. Clark, C. G., and J. R. Vane. 1961. The cardiac sphincter in the cat. *Gut.* **2**: 252-262.
6. Langley, J. N. 1898. On inhibitory fibers in the vagus for the end of the esophagus and the stomach. *J. Physiol.* **23**: 407-414.
7. Davenport, H. W. 1971. *Physiology of the Digestive Tract*. Year Book Medical Publishers, Inc., Chicago, Ill. 3rd edition. 13-27.
8. Ellis, F. H., Jr., and A. M. Olsen. 1969. Achalasia of the esophagus. *Major Probl. Clin. Surg.* **9**: 15-43.
9. Christensen, J. 1971. The controls of gastrointestinal movements: some old and new views. *N. Engl. J. Med.* **285**: 85-98.
10. Cohen, S., and L. D. Harris. 1972. The lower esophageal sphincter. *Gastroenterology.* **63**: 1066-1073.
11. Pope, C. E., II. 1973. The Esophagus, Physiology. In *Gastrointestinal Disease*. M. H. Sleisenger and J. S. Fordtran, editors. W. B. Saunders Company, Philadelphia, Pa. 1st edition. 83-89.
12. Crispin, J. S., D. K. McIver, and J. F. Lind. 1967. Manometric study of the effect of vagotomy on the gastroesophageal sphincter. *Can. J. Surg.* **10**: 299-303.
13. Lind, J. F., J. S. Crispin, and D. K. McIver. 1968. Effect of atropine on gastroesophageal sphincter. *Can. J. Physiol. Pharmacol.* **46**: 233-238.
14. Cohen, S., R. Fisher, and A. Tuch. 1972. The site of denervation in achalasia. *Gut.* **13**: 556-558.
15. Christensen, J., and G. F. Lund. 1969. Esophageal responses to distension and electrical stimulation. *J. Clin. Invest.* **48**: 408-419.
16. Goyal, R. K., S. Rattan, and T. Hersh. 1973. Comparison of the effects of prostaglandins E₁, E₂, and A₂ and of hypovolumic hypotension on the lower esophageal sphincter. *Gastroenterology.* **65**: 608-612.
17. Goyal, R. K., and S. Rattan. 1973. Mechanism of the lower esophageal sphincter relaxation. Action of prostaglandin E₁ and theophylline. *J. Clin. Invest.* **52**: 337-341.
18. Christensen, J., B. W. Freeman, and J. K. Miller. 1973. Some physiological characteristics of the esophagogastric junction in the opossum. *Gastroenterology.* **64**: 1119-1125.
19. Cohen, S., and F. Green. 1973. The mechanics of esophageal muscle contraction. Evidence of an inotropic effect of gastrin. *J. Clin. Invest.* **52**: 2029-2040.
20. Lipshutz, W., A. F. Tuch, and S. Cohen. 1971. A comparison of the site of action of gastrin I on lower esophageal sphincter and antral circular smooth muscle. *Gastroenterology.* **61**: 454-460.
21. Cohen, B. R., and M. Guelrund. 1971. "Cardiospasm" in achalasia: demonstration of supersensitivity of the lower esophageal sphincter. *Gastroenterology.* **60**: 769. (Abstr.)
22. Cohen, S., W. Lipshutz, and W. Hughes. 1971. Role of gastrin supersensitivity in the pathogenesis of lower esophageal sphincter hypertension in achalasia. *J. Clin. Invest.* **50**: 1241-1247.
23. Bettarello, A., S. G. Tuttle, and M. I. Grossman. 1960. Effect of autonomic drugs on gastroesophageal reflux. *Gastroenterology.* **39**: 340-346.

⁴R. K. Goyal and S. Rattan. Unpublished observations.