

# FTY720 stimulates multidrug transporter- and cysteinyl leukotriene-dependent T cell chemotaxis to lymph nodes

Shaun M. Honig,<sup>1</sup> Shuang Fu,<sup>1</sup> Xia Mao,<sup>1</sup> Adam Yopp,<sup>1</sup> Michael D. Gunn,<sup>2</sup> Gwendalyn J. Randolph,<sup>1</sup> and Jonathan S. Bromberg<sup>1,3</sup>

<sup>1</sup>Carl C. Icahn Center For Gene Therapy and Molecular Medicine, Mount Sinai School of Medicine, New York, New York, USA

<sup>2</sup>Departments of Medicine and Immunology, Duke University Medical Center, Durham, North Carolina, USA

<sup>3</sup>Recanati/Miller Transplantation Institute, Mount Sinai School of Medicine, New York, New York, USA

FTY720 is a sphingosine-derived immunosuppressant. Phosphorylated FTY720 promotes T cell homing from spleen and peripheral blood to LNs by acting as an agonist for sphingosine-1-phosphate (S1P) receptors. Here we demonstrate that FTY720 enhances the activity of the sphingosine transporter *Abcb1* (*Mdr1*) and the leukotriene C<sub>4</sub> transporter *Abcc1* (*Mrp1*). Both transporters must be active for FTY720-mediated T cell migration and LN homing. Migration and homing driven by FTY720, phosphorylated FTY720, or S1P also require 5-lipoxygenase-mediated synthesis of cysteinyl leukotrienes and their efflux from the cell. FTY720-mediated LN homing events further downstream are dependent on CCL19, CCL21, VLA-4 $\alpha$ , and CD44. Use of T cells deficient in 5-lipoxygenase, *Abcb1*, and *Abcc1*, and comparison of the effects of FTY720 with those of S1P, suggest a model of sequential engagement of *Abcb1*, S1P receptors, 5-lipoxygenase, and *Abcc1* to enhance T cell migration and homing.

*J. Clin. Invest.* 111:627–637 (2003). doi:10.1172/JCI200316200.

## Introduction

FTY720 is a synthetic sphingosine immunosuppressant that prolongs the survival of allografts without impairing normal T and B cell activation (1). In vitro studies have proposed that FTY720, like other sphingosine derivatives, may cause apoptotic death of the T cell, although the concentrations needed for this effect are greater than the normal therapeutic dose (2). FTY720 may also prolong graft survival by decreasing T cell infiltration into allografts or otherwise altering normal T cell trafficking. Recent studies demonstrate the disappearance of lymphocytes, especially T cells, from peripheral blood and spleen within 3–24 hours after a single oral dose of the drug. Concurrently, there is a marked increase in the number of lymphocytes in peripheral LNs, mesenteric LNs, and Peyer's patches (3). The LN sequestration of lymphocytes may be involved in the immunosuppressive effects of FTY720, as regulated trafficking of lymphocytes is necessary for systemic immune responses and allograft rejection (4, 5).

Received for publication June 14, 2002, and accepted in revised form December 9, 2002.

**Address correspondence to:** Jonathan S. Bromberg, Mount Sinai School of Medicine, One Gustave L. Levy Place, Box 1104, New York, New York 10029-6574, USA. Phone: (212) 659-8008; Fax: (212) 348-2474; E-mail: jon.bromberg@mountsinai.org.

**Conflict of interest:** The authors have declared that no conflict of interest exists.

**Nonstandard abbreviations used:** sphingosine-1-phosphate (S1P); sphingosine-1-phosphate receptor (S1PR); leukotriene (LT); cysteinyl leukotriene (cysLT); cysteinyl leukotriene receptor (cysLTR); 5-lipoxygenase (5-LO); cinnamyl-3,4-dihydroxy- $\alpha$ -cyanocinnamate (CDC).

A recent report demonstrates that FTY720 becomes phosphorylated in vivo and then acts as a potent agonist for multiple sphingosine-1-phosphate (S1P) receptors (S1PRs) (6). S1PR activation seems responsible for downstream events that lead to lymphocyte homing. However, the cellular and molecular mechanisms are not understood. Recent studies demonstrate a novel role for lipid mediators in LN homing of DCs. A blind screening of neutralizing mAb's led to the discovery that the lipid transporter ABCB1 (previously called MDR-1 and *P*-glycoprotein; for new nomenclature, see <http://www.gene.ucl.ac.uk/nomenclature/genefamily/abc.html>) regulates human DC migration to afferent lymphatics (7). Coupled with the hydrolysis of ATP, ABCB1 transports a wide range of compounds with various structures and targets, including ceramide analogs (8) and platelet-activating factor (9, 10), from the cytosol to the extracellular environment. A subsequent study demonstrated a role for another lipid transporter, *Abcc1* (previously called *Mrp1*), in the migration of DCs to lymphatics. *Abcc1* physiologically transports sphingolipid analogs and cysteinyl leukotriene C<sub>4</sub> (LTC<sub>4</sub>), which is metabolized in the extracellular environment to LTD<sub>4</sub> and LTE<sub>4</sub> (11, 12). Mice lacking the *Abcc1* gene show markedly decreased migration of Langerhans cells to LNs. Administration of exogenous cysteinyl leukotrienes (cysLTs) restores DC migration in these mice (13). These studies also demonstrate that both transporters are required for human DC migratory activity. However, whether the two transporters function in an interactive manner remains unclear (13, 14).

The mechanism by which *Abcc1* causes LN homing of DCs was further shown to be chemokine-mediated.

Experiments demonstrated a moderate decrease in chemotaxis of DCs to the chemokine CCL21, and a marked decrease in chemotaxis to submaximal doses of CCL19, in cells that lacked the *Abcc1* transporter. Pretreatment with exogenous *cysLTs*, however, was able to induce strong chemotaxis to CCL19 in these cells (13). The  $LTC_4$  that is transported through *Abcc1* appears to act in an autocrine fashion to trigger chemotaxis to CCL19 and migration from the epidermis to the LNs. How the *cysLTs* promote chemotaxis is still not understood (14).

We have investigated the mechanism of FTY720-induced migration of T cells to LNs by focusing on these molecular activities. Our results demonstrate that FTY720 enhances T cell *Abcb1* and *Abcc1* efflux activity and promotes the accumulation of 5-lipoxygenase-dependent (5-LO-dependent) metabolites in culture medium. This activity in turn enhances CCL19- and CCL21-dependent T cell migration and VLA-4 $\alpha$ - and CD44-dependent LN homing. Use of T cells deficient in 5-LO, *Abcb1*, and *Abcc1*, and comparison of the effects of FTY720 to those of S1P, suggest a model of sequential engagement of *Abcb1*, S1PRs, 5-LO, and *Abcc1* to enhance T cell migration and homing.

## Methods

**Mice.** C57BL/6, *fvb*, C57BL/6 *CD62L*<sup>-/-</sup> (15), B6/129 5-LO<sup>-/-</sup> (16), and B6/129 hybrid mice 8–10 weeks of age were purchased from The Jackson Laboratory (Bar Harbor, Maine, USA). *Fvb Abcb1*<sup>-/-</sup> (17) mice were purchased from Taconic Laboratories (Germantown, New York, USA). *Fvb Abcc1*<sup>-/-</sup> (18) mice and C57BL/6 *plt* mice (19) were maintained in our facility. C57BL/6 *FucTVII*<sup>-/-</sup> mice (20) were a gift from John Lowe (University of Michigan, Ann Arbor, Michigan, USA). *CX3CR1*<sup>-/-</sup> mice (21) were a gift from Steffen Jung and Dan Littman (New York University, New York, New York, USA). All mice were housed in a specific pathogen-free facility in microisolator cages. All experiments were performed with age- and sex-matched mice in accordance with Association for the Assessment and Accreditation of Laboratory Animal Care-approved criteria.

**Reagents.** The R1-2 rat IgG2b anti-murine VLA-4 $\alpha$ , KM-201 rat IgG1 anti-CD44, and MEL-14 rat IgG2a anti-murine CD62L hybridomas were purchased from the American Type Culture Collection (Rockville, Maryland, USA). All hybridomas were grown in culture, and supernatants were purified over protein G or A columns (Amersham Pharmacia Biotech, Piscataway, New Jersey, USA). R-PE-conjugated rat anti-mouse CD8 $\alpha$  mAb, FITC-conjugated rat anti-mouse CD4 mAb, and the annexin V apoptosis detection kit were purchased from Pharmingen (San Diego, California, USA). R-PE-conjugated rat IgG2b isotype standard and rat IgG2b mAb isotype standard were purchased from Caltag Laboratories Inc. (Burlingame, California, USA). MRPr1 rat IgG2a anti-human ABCC1 Ab was purchased from Alexis Biochemicals (San Diego, California, USA). R-PE-conjugated goat F(ab')<sub>2</sub> anti-rat Ig was

purchased from Biosource International Inc. (Camarillo, California, USA). LTD<sub>4</sub>, MK571, AA-861, S1P, and cinnamyl-3,4-dihydroxy- $\alpha$ -cyanocinnamate (CDC) were purchased from BIOMOL Research Laboratories Inc. (Plymouth Meeting, Pennsylvania, USA). PSC833 was a gift from Novartis Pharma AG (Basel, Switzerland). Fluo-3 and DiOC<sub>2</sub> were obtained from Molecular Probes Inc. (Eugene, Oregon, USA). Murine CCL19, human CCL21, murine RANTES, and murine CXCL13 were purchased from R&D Systems Inc. (Minneapolis, Minnesota, USA). FTY720, phosphorylated FTY720, the biologically active R-enantiomer AAL151, and the inactive L-enantiomer AAL149 (22) were kind gifts from V. Brinkmann (Novartis Pharma AG).

**Cell preparations.** Mice (two to three per group) were sacrificed, and spleen and LNs (cervical, periaortic, and mesenteric) were removed and gently dissociated into single-cell suspensions. Red blood cells were removed by tris-NH<sub>4</sub>Cl lysis. If indicated, cell suspensions were passed through T cell enrichment columns (R&D Systems Inc.); routinely, 85–95% of these cells were T cells. Cells were placed in complete RPMI medium (RPMI-1640 supplemented with 10% FCS, 1 mM sodium pyruvate, 2 mM L-glutamine, 100 IU/ml penicillin, 100  $\mu$ g/ml streptomycin, 1 $\times$  nonessential amino acids, and 2  $\times$  10<sup>-5</sup> M 2-mercaptoethanol). Lymphocytes were isolated from peripheral blood using density separation medium (Cedarlane Laboratories Ltd., Hornby, Ontario, Canada).

**Flow cytometry.** Cell washes and antibody dilutions were performed in PBS plus 1% BSA at 4°C. Flow cytometric analysis was performed on a FACScan flow cytometer (Becton Dickinson Immunocytometry Systems, San Jose, California, USA). Results are expressed as percentage of cells staining above background. To ensure that saturating concentrations were used, mAb's were titered at regular intervals during the course of these studies. For intracellular staining, a Cytotfix/Cytoperm kit was used according to the manufacturer's instructions (Pharmingen).

**Efflux assays.** T cells were incubated at 37°C for 30 minutes in 4  $\mu$ g/ml Fluo-3 or 20 ng/ml DiOC<sub>2</sub>, washed twice in cold PBS, and resuspended in complete medium. An aliquot was kept at 4°C to document the extent of dye uptake. FTY720 at the indicated concentrations, 25  $\mu$ M MK571, or 15  $\mu$ M PSC833 was added at this point, and cells were then incubated at 37°C for 60 minutes. Cells were then washed twice in cold PBS and analyzed by flow cytometry.

**Apoptosis assays.** T cells were purified from mouse spleens as described above and suspended in complete medium containing various doses and combinations of FTY720, MK571, PSC833, and camptothecin (Sigma-Aldrich, St. Louis, Missouri, USA). Cells were then incubated at 37°C for 4 hours. Following incubation, cells were resuspended in cold PBS and washed twice. Then cells were stained with annexin V-PE and 7-AAD according to the manufacturer's instructions (Pharmingen) and analyzed by flow cytometry.

**Migration assays.** We incubated  $5 \times 10^5$  T cells at  $37^\circ\text{C}$  for 1 hour with various doses of FTY720. Then the cells were resuspended in RPMI-1640 containing 0.5% BSA, and added in a volume of 100  $\mu\text{l}$  to the upper wells of a 24-well transwell plate (Corning International, Corning, New York, USA). Lower wells contained various doses of chemokines in 600  $\mu\text{l}$  RPMI-1640/0.5% BSA. The size of the pores separating the upper and lower wells was 5  $\mu\text{m}$ . Control wells received medium without chemoattractant. The number of T cells that migrated to the lower well following a 2-hour incubation was counted in three high-power fields using a hemocytometer.

**Statistics.** In vivo migration results represent pooled samples from two to three mice per experiment. In vitro migration results represent mean values of triplicate samples. All experiments were performed two to five times. Standard deviations and *P* values were calculated by Student's *t* test using Microsoft Excel software.

## Results

**FTY720 stimulates multidrug transporter efflux activity.** Given the importance of Abcc1 and Abcb1 in DC migration to the LNs and the fact that FTY720 bears structural features consistent with Abcb1 and Abcc1 substrates, we examined whether FTY720 would affect the function of these transporters in T cells in vitro. We assessed their functional activity by loading purified T cells with a fluorescent transport substrate in the presence of various doses of FTY720, and measuring the units of fluorescence retained in the cells over a period of time (23). Loss of fluorescence at  $37^\circ\text{C}$  indicates transport of the dye from the intracellular to the extracellular compartment, while cells held at  $4^\circ\text{C}$  do not export dye (7, 24). The substrate Fluo-3 requires Abcc1 for transport (13), while the substrate DiOC<sub>2</sub> is transported by Abcb1 more efficiently than by Abcc1 (G.J. Randolph, unpublished data).

Figure 1a shows that T cells from wild-type mice treated with FTY720 had a dramatic increase in Abcb1-mediated DiOC<sub>2</sub> efflux compared with controls. This dose of FTY720 had no adverse effects on cell viability. Abcc1 activity in resting T cells was very low but was significantly enhanced by FTY720 (Figure 1b). FTY720-mediated efflux was effectively blocked by the Abcb1 antagonist PSC833 (25) (Figure 1c) or the Abcc1 antagonist MK571 (26) (Figure 1d), indicating that FTY720 acts on the transporters to enhance efflux activity. Efflux assays performed on T cells purified from *Abcc1*<sup>-/-</sup> mice showed no efflux of Fluo-3 in cells either treated or not treated with FTY720 (Figure 1f). The effects of FTY720 on Abcb1 efflux remained intact in *Abcc1*<sup>-/-</sup> cells (Figure 1e). Flow cytometry using an antibody to Abcc1 showed that FTY720 had no effect on the level of Abcc1 expression (supplementary Figure 1, <http://www.jci.org/cgi/content/full/111/5/627/DC1>). Conversely, *Abcb1*<sup>-/-</sup> cells demonstrated little efflux activity for either substrate, and neither substrate's efflux activity was significantly enhanced by FTY720 (Figure 1, g and h). These results suggest that FTY720 sequentially activates Abcb1 upstream of Abcc1.

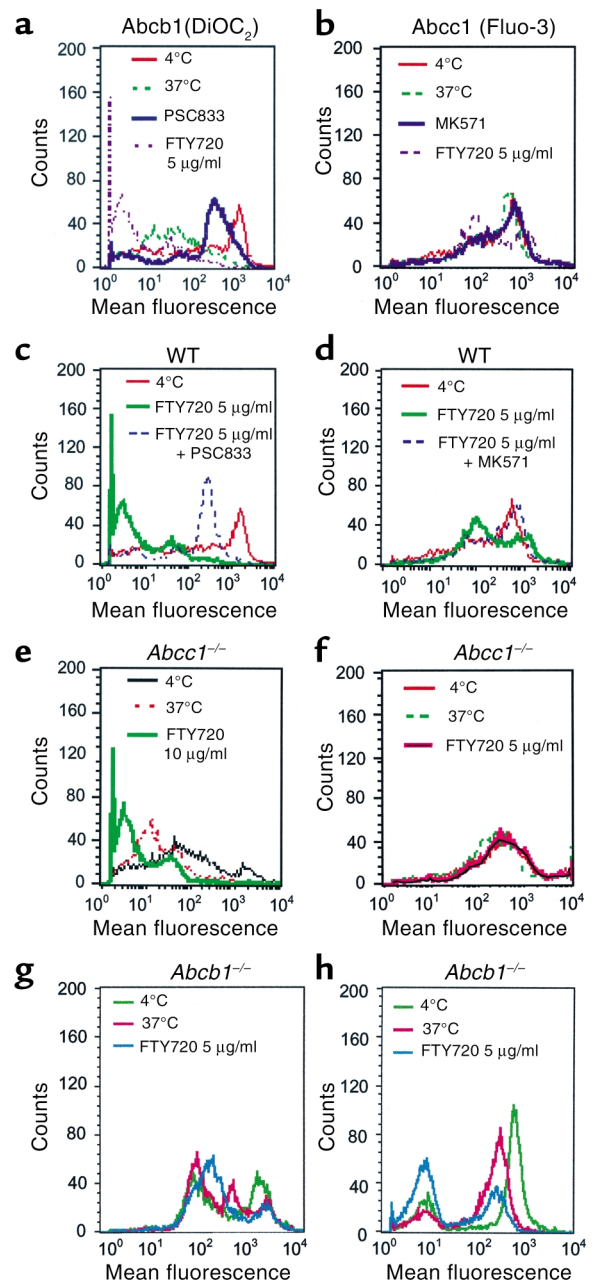

**Figure 1**

FTY720 enhances efflux activity of the Abcb1 and Abcc1 transporters. (a–d) Abcb1 efflux activity (a and c) and Abcc1 efflux activity (b and d) in wild-type C57BL/6 T cells. (e and f) Abcb1 (e) and Abcc1 (f) efflux activity in *Abcc1*<sup>-/-</sup> T cells. (g and h) Abcb1 (g) and Abcc1 (h) efflux activity in *Abcb1*<sup>-/-</sup> T cells.

**Efflux activity correlates with in vitro migration triggered by FTY720.** Next, the relation of multidrug transporter efflux activity to cell migration was examined. In vitro chemotaxis to CCL19 and CCL21 was assessed, since DC migration to these chemokines is sensitive to multidrug transporter efflux (13). Dose-response experiments demonstrated effective migration of purified T cells to 1  $\mu\text{g/ml}$  CCL19 or CCL21, with 20–40% of the total number of T cells migrating in individual experi-

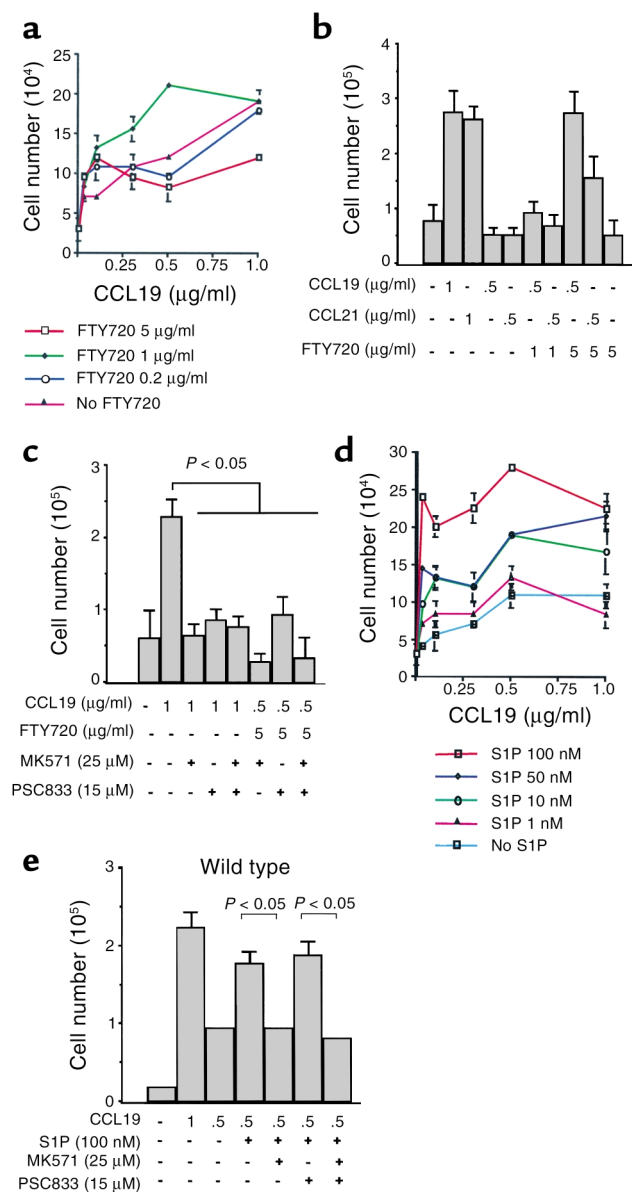

**Figure 2**  
FTY720 and S1P cause *Abcc1*- and *Abcb1*-dependent migration to CCL19 and CCL21. In vitro chemotactic response of T cells from wild-type mice to CCL19 or CCL21 is shown. FTY720, S1P, PSC833, and MK571 were added as indicated.

ments. Only about 10% of cells migrated to 0.5 μg/ml CCL19 or CCL21, and little migration above background occurred at lower doses. The migration response was chemotactic, since addition of chemokine to the upper chamber alone, or to both the upper and the lower chambers, resulted in no migration (not shown). Pretreating purified T cells from wild-type mice with doses of FTY720 that enhance efflux led to a shift of the migration curve, with enhanced chemotaxis to the lower doses of CCL19 and CCL21 (Figure 2, a and b) and 1–5 μg/ml FTY720 eliciting optimal responses. The results in Figure 2a also show evidence of desensitization with high doses of FTY720 plus high doses of

chemokine, resulting in diminished chemotaxis. Other experiments demonstrated that viability was unaffected by this dose of FTY720 (see Figure 7) and that, as expected, desensitization was dependent on time of incubation with FTY720 (not shown). Furthermore, T cell chemotaxis occurred only in response to the biologically active R-enantiomer, not the L-enantiomer (not shown), proving specificity of the migration effect.

To determine whether chemokine- and FTY720-induced migration was dependent on multidrug transporter function, wild-type cells were pretreated with MK571 or PSC833, with or without FTY720, and chemotaxis was then measured. Cells pretreated with the multidrug transporter blockers failed to migrate in response to CCL19, with or without FTY720 (Figure 2c). In vitro migration assays with T cells purified from *Abcc1*<sup>-/-</sup> and *Abcb1a/1b*<sup>-/-</sup> showed some migratory response to CCL19 alone, but FTY720 did not enhance migration (supplementary Figure 2, <http://www.jci.org/cgi/content/full/111/5/627/DC1>). Thus, multidrug transporter activity plays a pivotal role in both chemokine-mediated and FTY720-mediated migration of T cells.

Since phosphorylated FTY720 and S1P initiate S1PR activation and T cell homing (6), in vitro migration assays with wild-type or knockout T cells, in response to S1P or phosphorylated FTY720, were performed. Dose-response studies showed that, like FTY720, S1P enhanced the migration response to chemokines and shifted the migration curve (Figure 2d). S1P also enhanced the migration to CCL19 in wild-type and *Abcb1*<sup>-/-</sup> cells and cells treated with PSC833 (an *Abcb1* blocker), but not *Abcc1*<sup>-/-</sup> cells or cells treated with MK571 (an *Abcc1* blocker) (Figure 2e and supplementary Figure 2, <http://www.jci.org/cgi/content/full/111/5/627/DC1>). Similar experiments with phosphorylated FTY720 likewise demonstrated its dependence on *Abcc1* but not *Abcb1* to enhance migration (Table 1). Since *Abcb1* transports ceramides and sphingosines (8), these results suggest a molecular sequence in which sphingosines are directly or indirectly dependent on *Abcb1* for transport to the extracellular space so that phosphorylated sphingosines can then act in an autocrine fashion to activate S1PRs. The results suggest that *Abcb1* acts upstream of *Abcc1*. These results are consistent with the transporter studies shown in Figure 1, in which FTY720 sequentially activates *Abcb1* proximal to *Abcc1*.

*Multidrug transporters are required for FTY720-driven in vivo migration.* The role of the multidrug transporters in in vivo migration to FTY720 was examined in *Abcc1*<sup>-/-</sup>, *Abcb1a/1b*<sup>-/-</sup>, and wild-type control mice. Animals were treated orally with either 60 μg/d FTY720 or vehicle alone. After 6 days, LNs, peripheral blood, and spleens were harvested, and total lymphoid cells were counted, stained for CD4 and CD8, and analyzed by flow cytometry. As expected, wild-type mice treated with FTY720 showed an increase in total cell number and total T cell number in the LNs, with concurrent

**Table 1**  
Migration to phosphorylated FTY720 depends on Abcc1 but not Abcb1

	In vitro migration				Strain	Cells migrated ( $\times 10^4$ ) $\pm$ SEM <sup>A</sup>
	CCL19 (1 $\mu$ g/ml)	FTY720-P (50 nM)	MKS71 (25 $\mu$ M)	PSC833 (15 $\mu$ M)		
1	-	-	-	-	Wild type	2.04 $\pm$ 0.68
2	+	-	-	-		6.84 $\pm$ 1.0
3	+	-	+	-		3.12 $\pm$ 0.27
4	+	-	-	+		2.88 $\pm$ 0.27
5	-	+	-	-		1.20 $\pm$ 0.42
6	+	+	-	-		9.12 $\pm$ 0.50
7	+	+	+	-		1.61 $\pm$ 0.71 <sup>B</sup>
8	+	+	-	+		6.12 $\pm$ 0.99
9	-	-	-	-	<i>Abcc1</i> <sup>-/-</sup>	1.3 $\pm$ 0.5
10	1 $\mu$ g	-	-	-		28.5 $\pm$ 1.1
11	0.5 $\mu$ g	-	-	-		19.2 $\pm$ 1.5
12	0.5 $\mu$ g	FTY720 (1 $\mu$ g)	-	-		23.6 $\pm$ 3.9
13	0.5 $\mu$ g	FTY720-P (50 nM)	-	-		20.0 $\pm$ 1.9 <sup>C</sup>
14	1 $\mu$ g	FTY720-P (50 nM)	-	-		22.3 $\pm$ 1.9
15	-	-	-	-	<i>Abcb1</i> <sup>-/-</sup>	0.8 $\pm$ 0.3
16	1 $\mu$ g	-	-	-		21.8 $\pm$ 1.4
17	0.5 $\mu$ g	-	-	-		17.9 $\pm$ 1.6
18	0.5 $\mu$ g	FTY720 (1 $\mu$ g)	-	-		12.7 $\pm$ 1.7
19	0.5 $\mu$ g	FTY720-P (50 nM)	-	-		24.7 $\pm$ 1.4 <sup>D</sup>
20	1 $\mu$ g	FTY720-P (50 nM)	-	-		30.8 $\pm$ 1.8 <sup>E</sup>
21	-	FTY720-P (50 nM)	-	-		1.2 $\pm$ 0.9
22	-	FTY720 (1 $\mu$ g)	-	-		1.3 $\pm$ 1.0

<sup>A</sup>5  $\times 10^5$  cells initial input. <sup>B</sup>*P* < 0.001 vs. groups 6 and 8. <sup>C</sup>*P* not significant vs. group 11. <sup>D</sup>*P* < 0.001 vs. groups 17 and 18. <sup>E</sup>*P* < 0.001 vs. group 16.

decreases in the spleen and peripheral blood. On the other hand, both *Abcc1*<sup>-/-</sup> and *Abcb1*<sup>-/-</sup> mice treated with FTY720 showed a decrease in peripheral blood T cell counts but did not demonstrate an increase in LN T cell counts (T cell results, Figure 3; total cell counts, supplementary Figure 3, <http://www.jci.org/cgi/content/full/111/5/627/DC1>). Interestingly, the depletion of spleen cells that is normally observed in FTY720-treated wild-type mice was not observed in *Abcb1*<sup>-/-</sup> mice and was less substantial in *Abcc1a/1b*<sup>-/-</sup> mice. These data suggest that FTY720 may redirect T cell trafficking to the spleen in the absence of a capacity to promote LN homing of T cells. Also, while T cell counts changed in peripheral blood or spleen, the total number of cells in the three lymphoid compartments remained insensitive to FTY720. Overall, the results demonstrate that multidrug transporter activity is critical for FTY720-induced LN homing or sequestration of T cells in vivo.

FTY720-induced in vitro migration is dependent on 5-LO. *Abcc1*-mediated migration of DCs is dependent on the efflux of cysLTs, specifically LTC<sub>4</sub>, through the mul-

tidrug transporters (13). Since 5-LO is normally expressed in both resting and activated T cells (27) and mice that lack 5-LO are incapable of producing cysLTs, we examined whether the cysLTs played a similar role in FTY720- and S1P-mediated T cell migration. The results demonstrate that purified T cells from *5-LO*<sup>-/-</sup> mice, or wild-type T cells treated with the 5-LO blocker AA-861, did not migrate to CCL19 or CCL21 plus FTY720 or S1P in vitro. In contrast, T cells pretreated with the 12-LO blocker CDC demonstrated normal FTY720-mediated migration (Figure 4, a-d; and supplementary Figure 4, <http://www.jci.org/cgi/content/full/111/5/627/DC1>). The addition of the exogenous cysLT LTD<sub>4</sub>, following pretreatment with AA-861, restored migration (Figure 4e). In contrast to DCs, T cells do migrate to the higher doses of CCL19 alone when 5-LO is

absent (Figure 4b) or blocked (Figure 4a). Additional controls showed that neither 5-LO deficiency nor the 5-LO blockers affect the activity of the multidrug transporters in response to FTY720 (not shown). In conjunction with migration results showing that neither FTY720 nor S1P enhances migration in cysLT transporter-deficient *Abcc1*<sup>-/-</sup> T cells (Figures 2 and 3), these findings support a molecular sequence in which S1PR activation directly or indirectly enhances 5-LO

**Figure 3**

FTY720 causes *Abcc1*- and *Abcb1*-dependent LN homing in vivo. In vivo migration from peripheral blood and spleen to LNs in response to FTY720 in *fvb* wild type (a), *Abcc1*<sup>-/-</sup> (b), and *Abcb1*<sup>-/-</sup> (c). Total T cells are indicated.

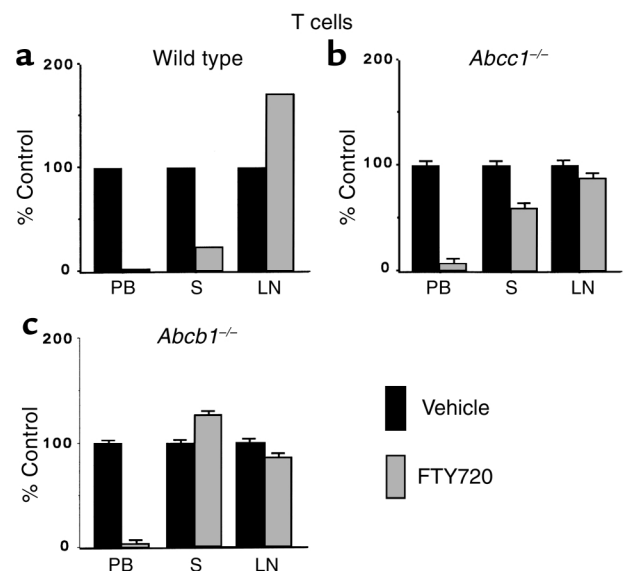

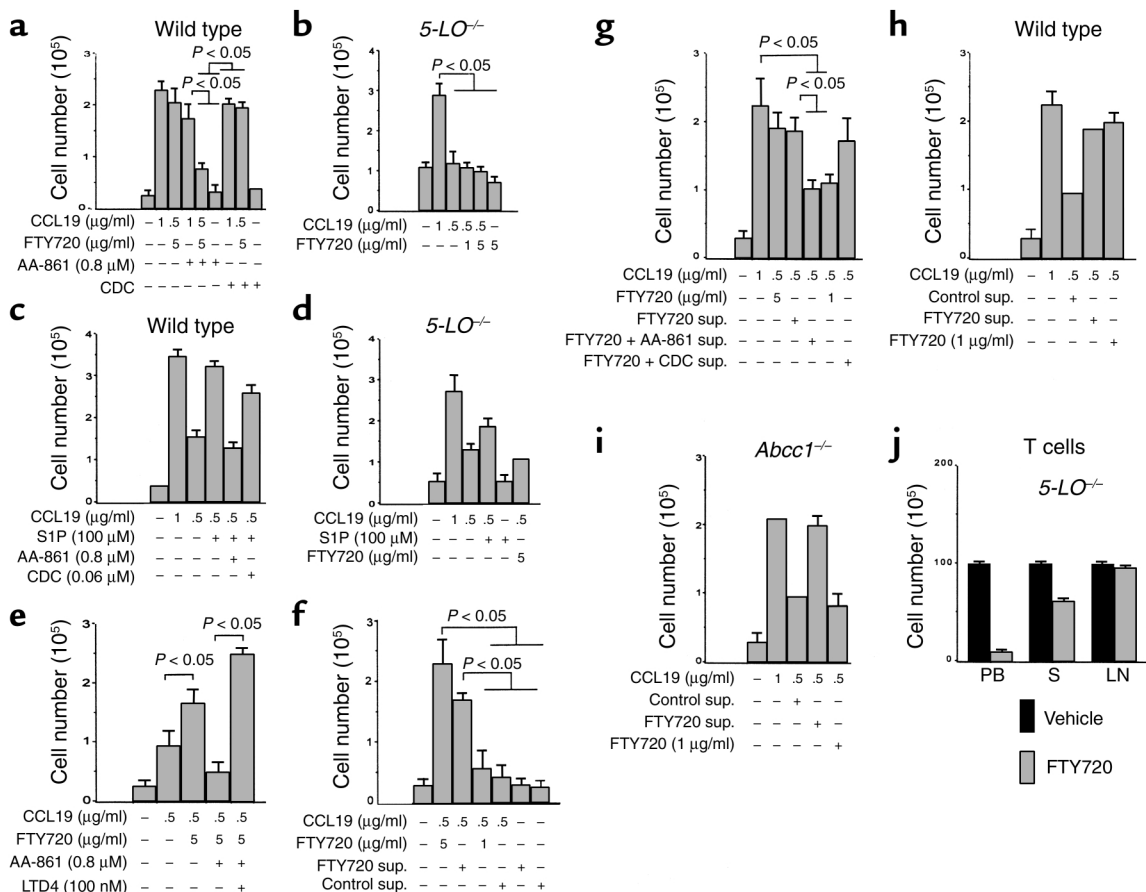

**Figure 4**

FTY720-mediated migration and S1P-mediated migration are dependent on cysLTs. (a and b) In vitro chemotactic response of T cells from wild-type or 5-LO<sup>-/-</sup> mice to CCL19 and FTY720 plus the 5-LO blocker AA-861 or the 12-LO blocker CDC. (c and d) Chemotactic response of T cells from 5-LO<sup>-/-</sup> and wild-type mice to CCL19 and S1P plus AA-861 or CDC. (e) Chemotactic response of T cells treated with CCL19 and with FTY720, FTY720 plus AA-861, or FTY720 plus AA-861 plus LTD<sub>4</sub>. (f) In vitro chemotactic response of T cells treated with FTY720 or FTY720 supernatant. (g) Chemotactic response of T cells treated with supernatants from FTY720, FTY720 plus AA-861, or FTY720 plus CDC-treated T cells. (h and i) Chemotactic response of *fvb* wild-type or *fvb* *Abcc1*<sup>-/-</sup> T cells treated with CCL19 and FTY720 or supernatant from FTY720-treated T cells. (j) In vivo migration from peripheral blood and spleen to LNs in response to FTY720 in 5-LO<sup>-/-</sup> mice. Total T cells are indicated.

activity, LTC<sub>4</sub> synthesis, and cysLT transport by *Abcc1* from the cytosol to the extracellular space with autocrine activation of the cysLT receptor (cysLTR). In vivo migration studies using 5-LO<sup>-/-</sup> mice were performed as well. The results showed that FTY720 was not able to cause LN homing in these mice (Figure 4j). In sum, 5-LO is required for in vitro and in vivo migration to FTY720.

*5-LO activity causes cysLT secretion.* Since this model predicts that cysLT secretion is necessary for migration, supernatants from FTY720-treated cells should contain cysLTs and enhance in vitro migration. To test this, purified T cells from wild-type mice were treated with FTY720, and the supernatant was collected and diluted 1:5 to make the final concentration of FTY720 in the supernatant too low to enhance migration. The supernatant was then added, along with CCL19, to purified T cells from wild-type mice. The results show that FTY720 supernatant but not the direct addition of FTY720 caused enhanced

migration to the suboptimal dose of chemokine (Figure 4f). The activity of the supernatant was abrogated by addition of the 5-LO blocker AA-861 to the cells, but not by addition of the 12-LO blocker CDC (Figure 4g). The undiluted supernatant also enhanced migration in both *fvb* and *Abcc1*<sup>-/-</sup> cells, while FTY720 was effective only in both *fvb* wild-type and *fvb* *Abcc1*<sup>-/-</sup> cells (Figure 4, h and i; and Figure 2), giving further evidence against direct effects of FTY720. Since LTC<sub>4</sub> is the only 5-LO metabolite transported by *Abcc1*, these data are most consistent with cysLT secretion via *Abcc1* as the mechanism for FTY720-mediated increases in T cell migration.

*T cell migration in response to FTY720 is dependent on CCL19 and CCL21.* As shown previously and above, CCL19- and CCL21-driven migration of DCs and T cells is dependent on the multidrug transporters (13). The results above also demonstrate that FTY720 enhances T cell migration to suboptimal doses of CCL19 and CCL21 in a manner also dependent on the



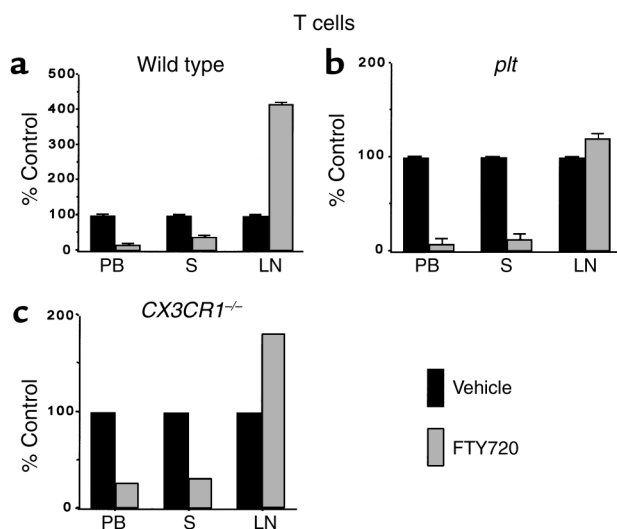

**Figure 5** FTY720 enhances migration to CCL19 and CCL21 but not to other chemokines. FTY720 causes T cell LN homing in vivo in C57BL/6 wild-type (a) and *CX3CR1*<sup>-/-</sup> (c) but not *plt* (b) mice.

multidrug transporters. To determine whether other chemokine responses are sensitive to this pathway, we examined in vitro migration to the chemokines CCL5 (RANTES) and CXCL13 (BCA-1), both of which are involved in T cell migration. The results show that both CCL5 and CXCL13 caused T cell migration at a dose of 1  $\mu\text{g/ml}$ , but not at a dose of 0.5  $\mu\text{g/ml}$ . Pretreating the cells with 1 or 5  $\mu\text{g/ml}$  FTY720 for 1 hour did not enhance migration to either chemokine, indicating that these chemokines and their receptors CCR1, CCR3, CCR5, and CXCR5 are unlikely to be involved in LN homing mediated by FTY720, multidrug transporters, or *cysLTs* (supplementary Figure 5, <http://www.jci.org/cgi/content/full/111/5/627/DC1>).

To determine whether CCL19 and CCL21 are required for in vivo LN sequestration, FTY720 was given orally at 60  $\mu\text{g/d}$  for 5 days to *plt* mice, natural mutants that lack the genes for CCL19 and stromal cell CCL21 but not for lymphatic CCL21. It was expected that FTY720 would not cause LN sequestration in these animals. Indeed, the numbers of LNs and of T cells in *plt* mice receiving FTY720 were similar to those in *plt* mice receiving vehicle alone (Figure 5a and supplementary Figure 5, <http://www.jci.org/cgi/content/full/111/5/627/DC1>). FTY720 did, however, cause a decrease in the numbers of splenic and peripheral blood T cells and total cells, similar to the effects of FTY720 in *Abcc1*<sup>-/-</sup> (Figure 3). It is possible that lymphatic CCL21 contributes to peripheral blood or splenic egress; it is also possible that other uncharacterized deletions in the *plt* mutant contribute to the observed defect. FTY720 was also given to mice that lacked the chemokine receptor *CX3CR1*, which binds fractalkine. FTY720 caused an increase in the number of LN T cells in these mice compared with mice that received vehicle alone, and there was a decrease in the

number of peripheral blood and splenic lymphocytes (Figures 5c). Thus, FTY720 requires CCL19 and/or stromal cell CCL21, but not a variety of other chemokines and their receptors, in order to promote LN sequestration or homing in vivo.

*T cell migration in response to FTY720 requires specific adhesion receptors.* While FTY720 acts on the multidrug transporters to cause *cysLT* efflux and subsequent migration to CCL19 and CCL21, the cells still require adhesion receptor molecules in order to attach to specific anatomic sites such as the LNs. We sought to determine which adhesion receptors are involved in FTY720-mediated LN sequestration, using in vivo migration assays. Wild-type mice were treated orally with 60  $\mu\text{g/d}$  FTY720, and intravenously on days 0 and 1 with 100  $\mu\text{g/d}$  of anti-CD62L (L-selectin), anti-CD44, or anti-VLA-4 $\alpha$  mAb. Control groups either received the mAb's alone or were untreated. Spleen, peripheral blood, and LNs were harvested and analyzed. The mice that received anti-CD62L mAb plus FTY720 showed a decrease in spleen and peripheral blood T cells, with a concurrent increase in LN T cells, indicating that FTY720-mediated LN sequestration is not dependent on the CD62L adhesion receptor (Figure 6 and supplementary Figure 6, <http://www.jci.org/cgi/content/full/111/5/627/DC1>). This finding is particularly notable

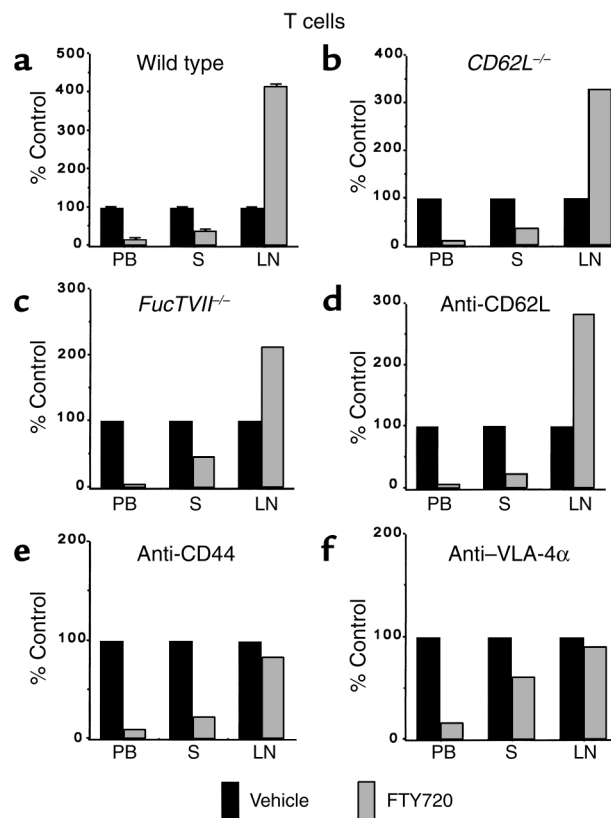

**Figure 6** FTY720 causes CD44- and VLA-4 $\alpha$ -dependent T cell LN homing in vivo. C57BL/6 wild-type (a), *L-selectin*<sup>-/-</sup> (b), and *FucTVII*<sup>-/-</sup> (c) mice and mice treated with anti-CD62L (d), anti-CD44 (e), or anti-VLA-4 $\alpha$  (f) mAb received either vehicle or FTY720.

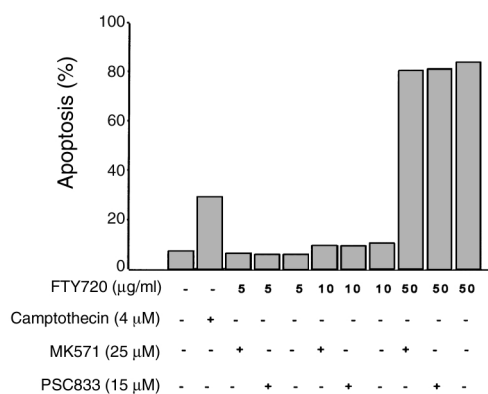

**Figure 7**  
FTY720 causes multidrug transporter-independent apoptosis. Percent apoptosis after the indicated treatments with FTY720 plus multidrug transporter blockers is shown.

since this mAb is able to drive naive T cells out of the LNs and into the spleen and peripheral blood (28, 29). However, mice that received anti-CD44 or anti-VLA-4 $\alpha$  mAb plus FTY720 showed a decrease in spleen and peripheral blood T cells, without an increase in LN cell number, indicating the importance of VLA-4 $\alpha$  and CD44 in FTY720-induced LN sequestration of T cells. We further examined the importance of adhesion receptors using knockout mice. Mice lacking L-selectin (*CD62L*<sup>-/-</sup>) or an L-selectin ligand (*FucTVII*<sup>-/-</sup>) and treated with FTY720 likewise showed an increase in LN cell numbers, with a decrease in cell numbers in the spleen and peripheral blood. These findings are similar to those of Chiba et al. (3), who showed in a rat model that the actions of FTY720 were independent of CD62L but not VLA-4 $\alpha$ . Flow cytometric analysis was performed to determine whether FTY720 affected the level of expression of the adhesion receptors.

Purified T cells were treated with FTY720 or medium and stained for CD44, VLA-4 $\alpha$ , or CD62L. The results showed similar levels of expression of VLA-4 $\alpha$ , CD44, and CD62L in cells treated or not treated with FTY720 (not shown). Since naive cells are generally CCR7<sup>+</sup>, while many memory and/or activated T cells are CCR7<sup>-</sup>, CD44<sup>+</sup>, and VLA-4 $\alpha$ <sup>+</sup>, the mAb's may be interfering with LN adhesion after entry. Further, CCL21 can stimulate integrin  $\alpha$ 4-dependent adhesion (30). Overall, the results from these in vivo migration assays demonstrate that FTY720-mediated LN homing is L-selectin- and L-selectin ligand-independent, and VLA-4 $\alpha$ - and CD44-dependent.

*The effect of FTY720 on efflux is not related to apoptosis.* Previous studies described an apoptotic effect of FTY720 on T cells in vitro. In order to test whether apoptosis was occurring at the doses of FTY720 used in our in vitro assays, cells were treated for 4 hours with 1, 5, 10, and 50  $\mu$ g/ml FTY720, 4  $\mu$ M camptothecin as a positive control, or complete medium alone. Apoptosis was measured using annexin V and 7-AAD staining. Cells that received 1 or 5  $\mu$ g/ml FTY720 showed

minimal apoptosis, while cells that received 10  $\mu$ g/ml showed increased apoptosis (Figure 7). Dramatic apoptosis was seen with a dose of 50  $\mu$ g/ml FTY720. Importantly, adding the multidrug transporter inhibitors MK571 and/or PSC833 had little effect on the levels of apoptosis seen at the various doses of FTY720. Additional experiments demonstrated that the 5-LO blocker and the CCL19 ligand did not inhibit the apoptotic response (not shown). These results demonstrate that FTY720 causes multidrug transporter-independent apoptosis, but not at the doses used in our study.

## Discussion

FTY720 causes LN homing or sequestration of T cells, and the mechanism for that action relates to S1PR activation and chemokine activity (6). Our results demonstrate that LN homing in response to FTY720 involves the multidrug transporters, 5-LO, and cysLTRs. FTY720 enhances the efflux activity of both multidrug transporters, which results in enhanced chemokine-mediated migration. Blocking Abcb1 prevents FTY720-enhanced Abcc1 efflux activity, but blocking Abcc1 does not prevent enhancement of Abcb1 activity. Blocking of or deficiency in either Abcb1 or Abcc1 prevents FTY720-enhanced T cell migration, while exogenous S1P or phosphorylated FTY720 enhances migration in T cells lacking Abcb1 activity but not Abcc1 activity. Given the evidence that S1P and phosphorylated FTY720 activate S1PRs, this suggests that sphingosines require Abcb1 transport activity to gain access to the extracellular space and activate S1PRs in an autocrine fashion. It remains to be determined how FTY720 enters the cell, whether it is phosphorylated primarily intracellularly or extracellularly, whether Abcb1 transports phosphorylated or only nonphosphorylated sphingosines, and how FTY720 stimulates Abcb1 efflux activity (31, 32).

These results in Figure 4 suggest that S1PR activation enhances Abcc1 efflux of LTC<sub>4</sub>, which then acts in an autocrine fashion on cysLTRs. This conclusion is strengthened by the finding that supernatants from

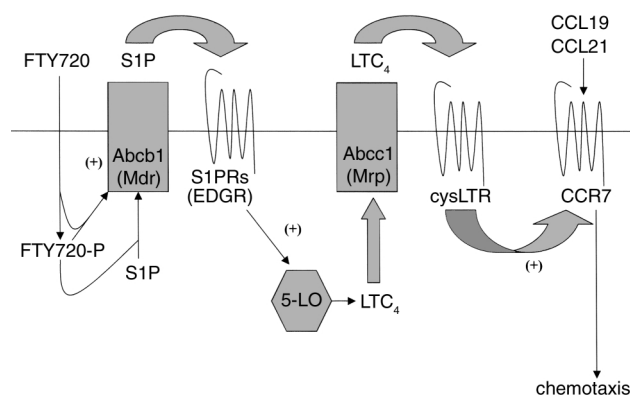

**Figure 8**  
Model for interactions among transporters and enzymes for autocrine or paracrine signaling in T cells leading to chemotaxis.



FTY720-treated T cells enhance migration in *Abcc1*<sup>-/-</sup> cells and that supernatant activity is blocked by inhibition of 5-LO. It is not yet clear whether S1PR activation directly affects 5-LO, *Abcc1*, or another molecular target(s). We propose a model in which multidrug transporters act in series with a number of G protein-linked transmembrane receptors (e.g., S1PR, cysLTR, and CCR7) and intracellular enzymes (e.g., 5-LO) to direct chemokine-mediated migration and homing (Figure 8). Clearly, not all chemokines function in this fashion, suggesting other pathways for their regulation. Further, while T cell migration in vitro and LN sequestration in vivo rely on these mechanisms, egress or accumulation of T cells and non-T cells in peripheral blood and spleen in *Abcb1a/1b*<sup>-/-</sup>, *Abcc1*<sup>-/-</sup>, and *5-LO*<sup>-/-</sup> mice (Figures 3 and 4) likely depends on other mechanisms of chemotactic regulation. Alternatively, in the absence of LN homing, cells may be migrating to interstitial or other lymphoid areas not sampled (e.g., gastrointestinal-associated lymphoid tissue, bronchial-associated lymphoid tissue, liver). The proposed molecular interactions may not necessarily take place within a single cell. It is possible that multiple cell types are involved in vivo, depending on their sensitivity to FTY720 and levels of expression of the various receptors and enzymes. Recent data show that phosphorylated FTY720 is generated poorly in whole blood but very rapidly in vivo (6), implying that vascular endothelial cells may be the site for this step. Preliminary data from our laboratory suggest that after ex vivo FTY720 treatment, adoptively transferred T lymphocytes induce migration of other lymphocytes in a paracrine fashion (our unpublished data).

The current study shows that homing to the CCR7 ligands CCL19 and CCL21 of whole T cell populations is sensitive to FTY720. Among T cell subsets it is likely that responsiveness to FTY720 varies. For example, memory T cells enter LNs via afferent lymphatic vessels, while naive T cells traffic directly from the blood through specialized high endothelial venules, implying the use of different molecular mechanisms (33). Additionally, memory T cells can be divided into two functionally distinct subsets, CCR7<sup>-</sup> and CCR7<sup>+</sup>. This suggests CCR7-independent homing to FTY720, for which Henning et al. have recently provided evidence in *CCR7*<sup>-/-</sup> mice (34). Even among CCR7<sup>+</sup> lymphocytes, there are distinct differences in response to CCL19 and CCL21. Reif et al. (35) recently showed that antigen engagement of LN B cells alters CCR7 expression, response to CCL19 and CCL21, and movement within LN microdomains. Thus, FTY720 may function to sensitize T cells to CCR7 ligands, thereby promoting LN retention.

Henning et al. also found that in *plt* mice FTY720 caused egress from the peripheral blood, suggesting CCL19- and CCL21-independent migration. However, while egress of T cells from peripheral blood was documented, accumulation in the LNs was not reported in *plt* mice. We also found that FTY720 caused egress of T

cells from peripheral blood, but that it did not induce T cell homing to LNs in *plt* mice. As mentioned above, this may imply a role for lymphatic CCL21 or for CCL19- and CCL21-independent egress. Since CCL19 and CCL21 can bind CCR11 (36) and CCL21 can stimulate CXCR3 (37), and these receptors in turn can be stimulated by a variety of other chemokines (38), there may be CCR7-independent (34), and CCL19- and CCL21-dependent or -independent, FTY720-mediated LN homing. The receptor(s) that might mediate this is currently unknown; and additional experiments did not show a role for FTY720-enhanced migration to CXCL9 (MIG) or CXCL10 (IP-10), conventional ligands for CXCR3 (S.M. Honig and J.S. Bromberg, unpublished data). We also observed that mice lacking *Abcc1*, CCL19 and CCL21, or CD44 and VLA-4 $\alpha$  mediated adhesion still had a decrease in peripheral blood and splenic T cells in response to FTY720 (Figures 3, 5, and 6) without LN accumulation. This suggests mechanistic differences among FTY720-induced egress from peripheral blood, splenic egress, and LN accumulation. Since we examined only a small number of chemokines and their receptors, it is likely that other chemokines and receptors are involved in FTY720-induced migration. Further examination of which specific T cell subsets, chemokines, and anatomic compartments are influenced by FTY720 will better define alternative mechanisms of action. As mentioned above, when some pathways are blocked, T and non-T cells may also be migrating to lymphoid organs or interstitial sites not sampled in our current studies.

Recent studies have examined the differences in distribution of the multidrug transporters in T cells. Older mice have a progressive accumulation of *Abcb1*<sup>+</sup> cells in both naive and memory subsets and CD4 and CD8 populations (39). Within the CD4 memory population, cells expressing *Abcb1* from both young and old mice showed reduced ability to proliferate and produced relatively low levels of cytokines during in vitro responses (40). Therefore, heterogeneity in transporter expression may also lead to heterogeneity in T cell responses to FTY720.

While this report shows the involvement of *Abcc1* and *Abcb1* in T cell migration, Robbiani et al. originally showed the importance of *Abcc1* and *Abcb1* in CCL19-dependent DC migration (13). Gunn et al. demonstrated that *plt* mice have decreased DC migration into the T cell zone of the LN, further illustrating the importance of CCL19 and CCL21 in DC homing to the LNs (41). It is noteworthy that T cells can migrate in response to optimal doses of CCL19 and CCL21 in the absence of 5-LO (Figure 4), while DCs may be more dependent on this enzyme activity in vivo (13). 5-LO activity and cysLT efflux are required, however, for FTY720-enhanced T cell migration. Thus, T cells and DCs appear to differ in molecular regulation of responses to CCL19 and CCL21. Future studies will need to examine how FTY720 affects DC migration. DCs, like T and B cells, also differ in their expression of

CCR7. DCs treated with type 1 IFN showed an upregulation of CCR7 (42). Also, mature DCs express higher levels of CCR7 than do immature DCs (43). Thus, FTY720 may have different effects on DC subpopulations, depending on the levels of CCR7 expression.

The ability of FTY720 to cause homing of T cells to the LNs may explain one immunosuppressive property of the drug, as it may prevent effector cells from entering the graft. This is supported by the findings of Pinschewer et al., who demonstrated that FTY720 did not affect induction and expansion of cytotoxic T cells but caused a shift in distribution of lymphocytes from the spleen to the peripheral LNs (1). Conversely, failure of the contribution of the cysLT pathway to LN migration may be responsible for accelerated renal allograft rejection observed in *5-LO<sup>-/-</sup>* mice (44). It is also possible that FTY720-driven homing to the LNs contributes to other aspects of immunosuppression. Previous studies suggest that the LN environment can be tolerogenic. Townsend and Goodnow reported that T-B and T-APC interactions in the LNs of TCR transgenic mice led to T cell activation, proliferation, and eventual disappearance, most likely due to activation-induced cell death (45). Starzl and Zinkernagel argue that direct localization of microbial antigen or alloantigen to the LNs results in tolerance via clonal deletion (46). Bromley et al. found that engagement of the CXCR3 and CCR7 chemokine receptors leads to immunosuppressive effects (47). In light of the demonstration that murine CCL21 binds to both CCR7 and CXCR3 (37), this may indicate that both receptors are important in FTY720-mediated LN homing and immunosuppression. Recent experiments in our laboratory demonstrate an important relationship between LN homing and alloantigen-specific tolerance (28). Mice treated with a tolerogenic mAb regimen had long-term allograft survival with alloantigen-specific tolerance. Administration of anti-CD62L mAb to these recipients caused rapid shedding of L-selectin and exit of T cells from the LNs, and anti-CD62L mAb-treated and *CD62L<sup>-/-</sup>* mice were unable to be tolerized. These results indicate that LN homing is necessary for tolerance induction. Importantly, graft survival and LN homing were restored in these mice when FTY720 was given concurrently (28). The presence of an LN homing pathway that is dependent on multidrug transporters, cysLT, CCL19, and CCL21 may therefore explain some of the immunosuppressive properties of FTY720. LN homing in the setting of an immunosuppressive or tolerogenic regimen could create an environment within the LNs that results in prolonged graft survival and alloantigen-specific tolerance.

### Acknowledgments

We thank Steffen Jung, Dan Littman, John Lowe, and Volker Brinkmann for providing valuable reagents. We acknowledge the technical contributions of Minwei Mao and Dan Chen. This work was supported by NIH grants R01 AI41428 (to J.S. Bromberg), AI49653 (to G.J. Ran-

dolph), and HL69446 (to G.J. Randolph), and by a Research Training Fellowship for Medical Students from the Howard Hughes Medical Institute (to S.M. Honig).

- Pinschewer, D.D., et al. 2001. FTY720 immunosuppression impairs effector-T-cell peripheral homing without affecting induction, expansion, and memory. *J. Immunol.* **164**:5761-5770.
- Nagahara, Y., Ikekita, M., and Shinomiya, T. 2000. Immunosuppressant FTY720 induces apoptosis by direct induction of permeability transition and release of cytochrome c from mitochondria. *J. Immunol.* **165**:3250-3259.
- Chiba, K., et al. 1998. FTY720, a novel immunosuppressant, induces sequestration of circulating mature lymphocytes by acceleration of lymphocyte homing in rats. I. FTY720 selectively decreases the number of circulating mature lymphocytes by acceleration of lymphocyte homing. *J. Immunol.* **160**:5037-5044.
- Butcher, E.C., and Picker, L.J. 1996. Lymphocyte homing and homeostasis. *Science.* **272**:60-66.
- Lakkis, F., Konieczny, B., and Inoue, Y. 2000. Immunologic 'ignorance' of vascularized organ transplants in the absence of secondary lymphoid tissue. *Nat. Med.* **6**:686-688.
- Mandala, S., et al. 2002. Alteration of lymphocyte trafficking by sphingosine-1-phosphate receptor agonists. *Science.* **296**:346-349.
- Randolph, G.J., et al. 1998. A physiologic function for p-glycoprotein (MDR1) during the migration of dendritic cells from skin via afferent lymphatics. *Proc. Natl. Acad. Sci. U. S. A.* **95**:6924-6929.
- van Helvoort, A., et al. 1996. MDR1 P-glycoprotein is a lipid translocase of broad specificity, while MDR3 P-glycoprotein specifically translocates phosphatidylcholine. *Cell.* **87**:507-517.
- Raggers, R.J., Vogels, I., and van Meer, G. 2001. Multidrug-resistance P-glycoprotein (MDR1) secretes platelet-activating factor. *Biochem. J.* **357**:859-865.
- Ernest, S., and Bello-Reuss, E. 1999. Secretion of platelet-activating factor is mediated by MDR1 P-glycoprotein in cultured human mesangial cells. *J. Am. Soc. Nephrol.* **10**:2306-2313.
- Leier, I., et al. 1994. The MRP1 gene encodes an ATP-dependent export pump for leukotriene C4 and structurally related conjugates. *J. Biol. Chem.* **269**:27807-27810.
- Raggers, R.J., van Helvoort, A., Evers, R., and van Meer, G. 1999. The human multidrug resistance protein MRP1 translocates sphingolipid analogs across the plasma membrane. *J. Cell Sci.* **112**:415-422.
- Robbiani, D.F., et al. 2000. The leukotriene C4 transporter MRP1 regulates CCL19 (MIP-3beta, ELC)-dependent mobilization of dendritic cells to lymph nodes. *Cell.* **103**:757-768.
- Randolph, G.J. 2001. Dendritic cell migration to lymph nodes: cytokines, chemokines, and lipid mediators. *Semin. Immunol.* **13**:267-274.
- Robinson, S.D., et al. 1999. Multiple, targeted deficiencies in selectins reveal a predominant role for P-selectin in leukocyte recruitment. *Proc. Natl. Acad. Sci. U. S. A.* **96**:11452-11457.
- Chen, X.S., Sheller, J.R., Johnson, E.R., and Funk, C.D. 1994. Role of leukotrienes revealed by targeted disruption of the 5-lipoxygenase gene. *Nature.* **372**:179-181.
- Schinkel, A.H., et al. 1997. Normal viability and altered pharmacokinetics in mice lacking *mdr1*-type (drug-transporting) P-glycoproteins. *Proc. Natl. Acad. Sci. U. S. A.* **94**:4028-4033.
- Lorcio, A., et al. 1998. Disruption of the murine MRP (multidrug resistance protein) gene leads to increased sensitivity to etoposide (VP-16) and increased levels of glutathione. *Cancer Res.* **57**:5238-5242.
- Nakano, H., et al. 1998. A novel gene mutant involved in T-lymphocyte-specific homing into peripheral lymphoid organs on mouse chromosome 4. *Blood.* **91**:2886-2895.
- Weninger, W., et al. 2000. Specialized contributions by  $\alpha(1,3)$ -fucosyltransferase-IV and FucT-VII during leukocyte rolling in dermal microvessels. *Immunity.* **12**:665-676.
- Jung, S., et al. 2000. Analysis of fractalkine receptor CX3CR1 function by targeted deletion and green fluorescent protein reporter gene insertion. *Mol. Cell. Biol.* **20**:4106-4114.
- Brinkmann, V., et al. 2001. FTY720: dissection of membrane receptor-operated, stereospecific effects on cell migration from receptor-independent antiproliferative and apoptotic effects. *Transplant. Proc.* **33**:3078-3080.
- Chaudhary, P.M., and Roninson, I.B. 1991. Expression and activity of p-glycoprotein, a multidrug efflux pump, in human hematopoietic stem cells. *Cell.* **66**:85-94.
- Lohoff, M., et al. 1998. A multidrug resistance protein (MRP)-like transmembrane pump is highly expressed by resting murine T helper (Th)2 but not Th1 cells, and is induced to equal expression levels in Th1 and Th2 cells after antigenic stimulation in vivo. *J. Clin. Invest.* **101**:703-710.
- Sikic, B.I. 1997. Pharmacologic approaches to reversing multidrug resistance. *Semin. Hematol.* **34**:40-47.
- Jones, T.R., et al. 1989. Pharmacology of L-660,711 (MK-571): a novel potent and selective leukotriene D<sub>4</sub> receptor antagonist. *Can. J. Physiol. Pharmacol.* **67**:17-31.

27. Cifone, M.G., Cironi, L., Santoni, A., and Testi, R. 1995. Diacylglycerol lipase activation and 5-lipoxygenase activation and translocation following TCR/CD3 triggering in T cells. *Eur. J. Immunol.* **25**:1080-1086.
28. Bai, Y., et al. 2002. L-selectin lymph node occupancy is required to induce alloantigen specific tolerance. *J. Immunol.* **168**:1579-1589.
29. Lepault, F., Gangerault, M.C., Faveeuw, C., and Boitard, C. 1994. Recirculation, phenotype, and functions of lymphocytes in mice treated with monoclonal antibody MEL-14. *Eur. J. Immunol.* **24**:3106-3112.
30. Pachynski, R.K., Wu, S.W., Gunn, M.D., and Erle, D.J. 1998. Secondary lymphoid-tissue chemokine (SLC) stimulates integrin  $\alpha 4\beta 7$ -mediated adhesion of lymphocytes to mucosal addressin cell adhesion molecule-1 (MAdCAM-1) under flow. *J. Immunol.* **161**:952-956.
31. Olivera, A., and Spiegel, S. 2001. Sphingosine kinase: a mediator of vital cellular functions. *Prostaglandins Other Lipid Mediat.* **64**:123-134.
32. Mandala, S. 2001. Sphingosine-1-phosphate phosphatases. *Prostaglandins Other Lipid Mediat.* **64**:143-156.
33. Mackay, C.R., Marston, W.L., and Dudler, L. 1990. Naïve and memory T cells show distinct pathways of lymphocyte recirculation. *J. Exp. Med.* **171**:801-817.
34. Henning, G., et al. 2001. CC chemokine receptor 7-dependent and -independent pathways for lymphocyte homing: modulation by FTY720. *J. Exp. Med.* **194**:1875-1881.
35. Reif, K., et al. 2002. Balanced responsiveness to chemoattractants from adjacent zones determines B-cell position. *Nature.* **416**:94-99.
36. Gosling, J., et al. 2000. Cutting edge: identification of a novel chemokine receptor that binds dendritic cell- and T cell-active chemokines including ELC, SLC, and TECK. *J. Immunol.* **164**:2851-2856.
37. Soto, H., et al. 1998. The CC chemokine 6Ckine binds the CXC chemokine receptor CXCR3. *Proc. Natl. Acad. Sci. U. S. A.* **95**:8205-8210.
38. Nelson, P.J., and Krensky, A. 2001. Chemokines, chemokine receptors, and allograft rejection. *Immunity.* **14**:377-386.
39. Witkowski, J.M., and Miller, R.A. 1993. Increased function of P-glycoprotein in T lymphocytes of aging mice. *J. Immunol.* **150**:1296-1306.
40. Witkowski, J.M., Li, S.P., Gorgas, G., and Miller, R.A. 1994. Extrusion of the P-glycoprotein substrate rhodamine-123 distinguishes CD4 memory T cells subsets that differ in IL-2 driven IL-4 production. *J. Immunol.* **153**:658-665.
41. Gunn, M.D., et al. 1999. Mice lacking expression of secondary lymphoid organ chemokine have defects in lymphocyte homing and dendritic cell localization. *J. Exp. Med.* **189**:451-460.
42. Parlato, S., et al. 2001. Expression of CCR7, MIP-3 $\beta$ , and Th-1 chemokines in type I IFN-induced monocyte-derived dendritic cells; importance for the rapid acquisition of potent migratory and functional activities. *Blood.* **98**:3022-3029.
43. Sallusto, F., and Lanzavecchia, A. 2000. Understanding dendritic cell and T-lymphocyte traffic through the analysis of chemokine receptor expression. *Immunol. Rev.* **177**:134-140.
44. Goulet, G.L., et al. 2001. Deficiency of 5-lipoxygenase accelerates renal allograft rejection in mice. *J. Immunol.* **176**:6631-6636.
45. Townsend, S.E., and Goodnow, C.C. 1998. Abortive proliferation on rare T cells induced by direct or indirect antigen presentation by rare B cells in vivo. *J. Exp. Med.* **187**:1611-1621.
46. Starzl, T.E., and Zinkernagel, R.M. 1998. Antigen localization and migration in immunity and tolerance. *N. Engl. J. Med.* **339**:1905-1913.
47. Bromley, S.K., Peterson, D.A., Gunn, M.D., and Dustin, M.L. 2001. Hierarchy of chemokine receptor and TCR signals regulating T cell migration and proliferation. *J. Immunol.* **165**:15-19.